

# Rail-Mount Terminal Blocks with Screw and Stud Connection

Supplementary Catalog to Full Line Catalog, Volume 1 – Edition 2021

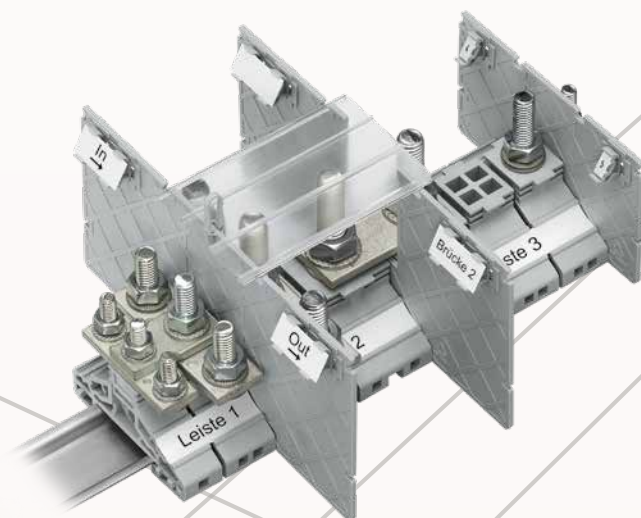

The new items in this catalog supplement products found in the following full line catalog:

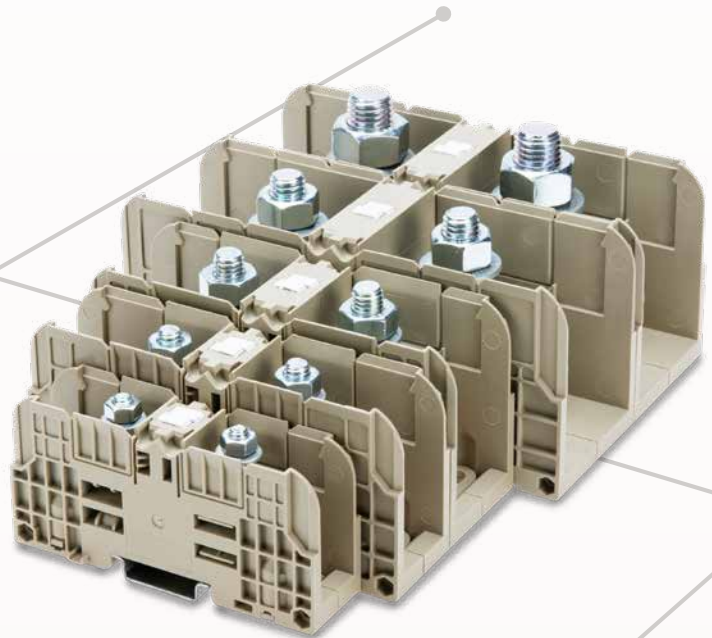
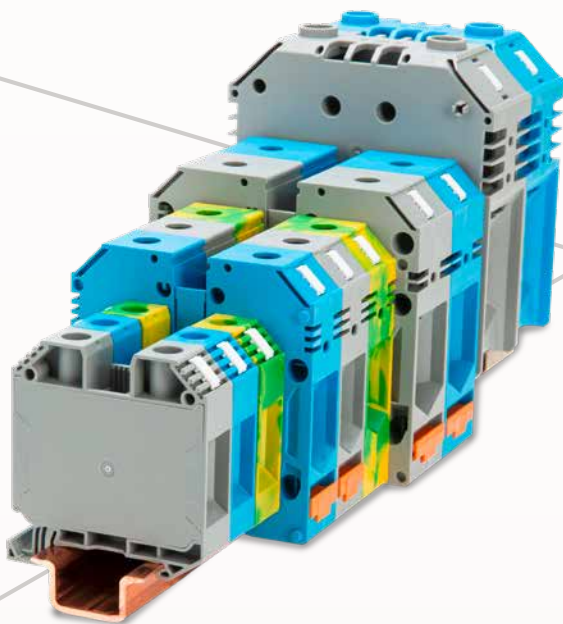

Volume 1

Rail-Mount Terminal Block Systems



## WAGO Rail-Mount Terminal Blocks with Screw and Stud Connection

	Through and Ground Conductor Terminal Blocks with Screw Connection 35 mm <sup>2</sup>	883 Series	4
	Through and Ground Conductor Terminal Blocks with Screw Connection 70 mm <sup>2</sup>	883 Series	6
	Through Terminal Blocks with Screw Connection 120 mm <sup>2</sup>	883 Series	8
	Through Terminal Blocks with Screw Connection 240 mm <sup>2</sup>	883 Series	10
	Stud Terminal Blocks with 2 Studs M6 (35 mm <sup>2</sup> ), M8 (70 mm <sup>2</sup> ), M10 (120 mm <sup>2</sup> ), M12 (185 mm <sup>2</sup> ), M16 (300 mm <sup>2</sup> )	884 Series	14
	Stud Terminal Blocks with 1 Stud M6 (35 mm <sup>2</sup> ), M8 (50 mm <sup>2</sup> ), M10 (120 mm <sup>2</sup> ), M12 (120 mm <sup>2</sup> )	885 Series	18
	Stud Terminal Blocks with 3 Studs M6 (35 mm <sup>2</sup> ), M8 (50 mm <sup>2</sup> ), M10 (120 mm <sup>2</sup> )	885 Series	20
	Accessories		22
	Item Number Index Addresses		27

# RAIL-MOUNT TERMINAL BLOCKS

## Screw Connection; 883 Series

### Operating Slot

Opening the clamping unit via

- Slot screwdriver for 35 mm<sup>2</sup>
- T-wrench for 70 mm<sup>2</sup>, 120 mm<sup>2</sup> and 240 mm<sup>2</sup>

### Jumper Slot

- Single jumper slot for 70 mm<sup>2</sup> and 120 mm<sup>2</sup>

### Jumper Slot

- Dual jumper slot for 35 mm<sup>2</sup>

### Snap-In Mounting Foot for DIN-35 Rails

- Snapping on one side for 35 mm<sup>2</sup> and 240 mm<sup>2</sup>
- Snapping on both sides for 70 mm<sup>2</sup> and 120 mm<sup>2</sup>

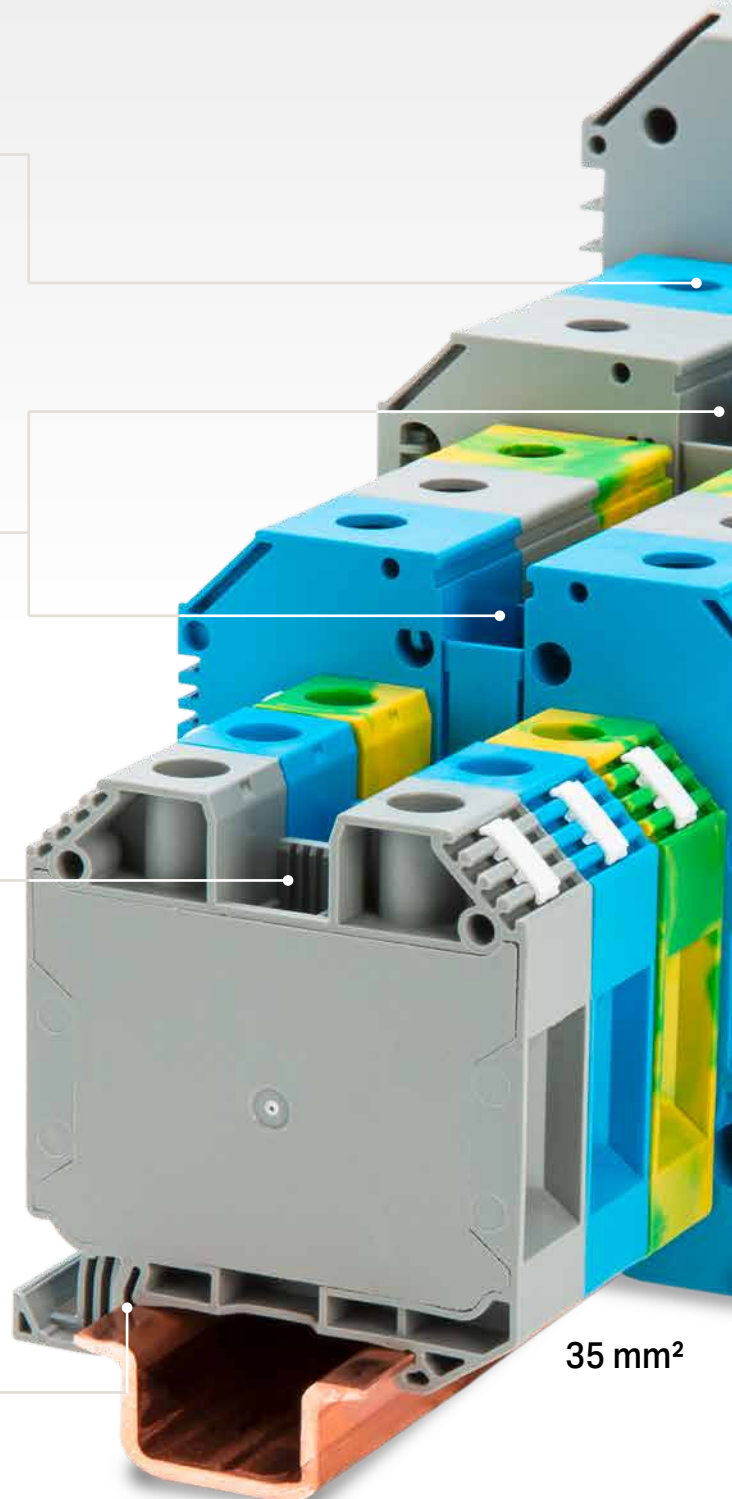



## Marking

- WMB
- WMB Inline
- Mini-WSB
- Mini-WSB Inline
- Marker carrier for marking strips

## Receptacle for Power Tap (on both sides)

- For potential distribution via power taps

## Conductor Entry

- Easy conductor insertion without conductor preparation up to 240 mm<sup>2</sup>
- Accommodates jumpers for 240 mm<sup>2</sup> screw terminal blocks

240 mm<sup>2</sup>

120 mm<sup>2</sup>

70 mm<sup>2</sup>

## Through Terminal Block, Ground Conductor Terminal Block, Power Tap; with Screw Connection 883 Series

### Technical Data

Nominal cross-section: 35 mm<sup>2</sup>

1.5 ... 50 mm<sup>2</sup> "s+st+f-st" ① | 16 ... 1/0 AWG

1000 V/8 kV/3 ② | 600 V, 150 A ③

I<sub>N</sub> 125 A (150 A) | 600 V, 150 A ④

Terminal block width: 16.1 mm / 0.634 inch

18 mm / 0.71 inch

Tightening torque: 3.2 ... 3.7 Nm

Screw thread: M6

Actuation type: Slot screwdriver; (6.5 x 1.2) mm blade

Insulation material: Polyamide 66 (PA66)

Flammability class UL 94: V0

Continuous operating temperature: -35 ... +105 °C



2-conductor through terminal block

Color	Item No.	PU
○ gray	883-3501	20
● blue	883-3504	20

### Item-Specific Accessories

Jumper; insulated; yellow

	2-way	883-3542	20
---	-------	----------	----

Protective warning marker; with high-voltage symbol

	yellow	883-3586	20
	white	883-3588	20

Screwless end stop; for DIN-35 rail; 10 mm wide

	gray	249-117	50 (25)
--	------	---------	---------

Screwless end stop; for DIN-35 rail; 14 mm wide

	gray	249-197	10
--	------	---------	----

### Technical Data

Nominal cross-section: 35 mm<sup>2</sup>

1.5 ... 50 mm<sup>2</sup> "s+st+f-st" ① | 16 ... 1/0 AWG

Terminal block width: 16.1 mm / 0.634 inch

18 mm / 0.71 inch

Tightening torque: 3.2 ... 3.7 Nm

Screw thread: M6

Actuation type: Slot screwdriver; (6.5 x 1.2) mm blade

Insulation material: Polyamide 66 (PA66)

Flammability class UL 94: V0

Continuous operating temperature: -35 ... +105 °C

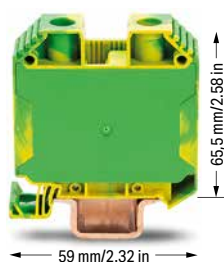

2-conductor ground terminal block; only suitable for DIN 35 x 15 rail; 2.3 mm thick; copper

Color	Item No.	PU
● green-yellow	883-3507	20

### Item-Specific Accessories

Protective warning marker; with high-voltage symbol

	yellow	883-3586	20
	white	883-3588	20

Screwless end stop; for DIN-35 rail; 10 mm wide

	gray	249-117	50 (25)
---	------	---------	---------

Screwless end stop; for DIN-35 rail; 14 mm wide

	gray	249-197	10
---	------	---------	----

### Technical Data

Nominal cross-section: 6 mm<sup>2</sup>

0.2 ... 10 mm<sup>2</sup> "s" ② | 22 ... 8 AWG

1000 V/6 kV/3 ③

I<sub>N</sub> 41 A (57 A)

Module width: 8.3 mm / 0.327 inch

10 mm / 0.39 inch

Tightening torque: 1.2 ... 2 Nm

Screw thread: M3.5

Actuation type: Slot screwdriver; (4 x 0.8) mm blade

Insulation material: Polyamide 66 (PA66)

Flammability class UL 94: V0

Continuous operating temperature: -35 ... +105 °C



Power tap

Color	Item No.	PU
● beige	883-3530	50

- ❶ Conductor range: 1.5 ... 50 mm<sup>2</sup> "s+st+f-st" and insulated ferrules: 1.5 ... 35 mm<sup>2</sup>
  - ❷ Conductor range: 0.2 ... 10 mm<sup>2</sup>"s+f-st" and insulated ferrules: 0.2 ... 6 mm<sup>2</sup>
  - ❸ 1000 V = rated voltage  
8 kV = rated impulse voltage  
3 = pollution degree
- Approvals and corresponding ratings, visit [www.wago.com](http://www.wago.com)



**Commoning**  
The 2-way jumper is inserted into one of the two center jumper slots. The dual jumper slot allows an unlimited, multiple potential distribution. The jumpers are designed for the rated current of the screw terminal block.



**Power tap**  
The power tap is inserted into the conductor entry and pressed indirectly against the current bar via the clamping bracket when the clamping point is actuated.



**Mounting and removing through terminal blocks**  
Mounting is performed by simply snapping the terminal block onto the DIN-rail. The fixed snap-in foot is put on first. Removal is performed by pushing back the movable snap-in foot and simultaneously tilting it off the rail.



**Commoning**  
The jumper can be removed from the jumper slot using an operating tool or a slotted screwdriver via the slots recessed in the housing.



**Marking**  
The screw terminal blocks can be labeled quickly and easily with the WMB Inline marking system. The markers are inserted into the receptacles provided for this purpose. The 2009-198 Marker Carrier allows marking strips to be used. For marking accessories, see pages 24 and 25.



**Mounting and removing ground conductor terminal blocks**  
Mounting is performed by simply snapping the terminal block onto the DIN-rail. The fixed snap-in foot is put on first. The DIN-rail is contacted via the ground foot. Removal is performed by pushing back the movable snap-in foot and simultaneously tilting it off the rail.



**Protective warning marker**  
The warning covers marked with a lightning arrow (high voltage) are snapped onto the screw terminal block from above and close the actuation slot. This safeguard prevents actuation of the clamping point under voltage and guarantees protection against accidental contact.



**Testing**  
Voltage measurements can be performed via the screw heads in the actuation slot (e.g., via 2-pole 206-707 Voltage Tester).



**Conductor termination and clamping point actuation**  
The stripped conductor is inserted into the clamping unit until it hits the backstop. By turning the screw to the right with a slotted screwdriver, the conductor is indirectly pressed against the current bar via the clamping bracket.

## Through Terminal Block, Ground Conductor Terminal Block, Power Tap; with Screw Connection 883 Series

### Technical Data

Nominal cross-section: 70 mm<sup>2</sup>

10 ... 95 mm<sup>2</sup> "s+st" ① | 6 ... 3/0 AWG

1000 V/8 kV/3 ③ | 600 V, 205 A 

I<sub>N</sub> 192 A (232 A) | 600 V, 205 A 

Terminal block width: 20.5 mm / 0.807 inch

 22 mm / 0.87 inch

Tightening torque: 6 ... 12 Nm

Screw thread: M8

Actuation type: T-wrench; 6 mm



Insulation material: Polyamide 66 (PA66)

Flammability class UL 94: V0

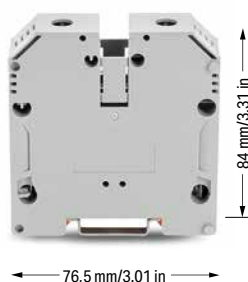
Continuous operating temperature: -35 ... +105 °C



2-conductor through terminal block

Color	Item No.	PU
 gray	883-7001	10
 blue	883-7004	10

### Item-Specific Accessories

#### Jumper bar; uninsulated

	2-way	883-7042	10
	3-way	883-7043	10
	4-way	883-7044	10

#### Protective warning marker; with high-voltage symbol

	yellow	883-7086	10
	white	883-7088	10

#### Insertion plate for flat cables

	uninsulated	883-7099	10
---	-------------	----------	----

#### Screwless end stop; for DIN-35 rail; 10 mm wide

	gray	249-117	50 (25)
---	------	---------	---------

#### Screwless end stop; for DIN-35 rail; 14 mm wide

	gray	249-197	10
---	------	---------	----

### Technical Data

Nominal cross-section: 70 mm<sup>2</sup>

10 ... 95 mm<sup>2</sup> "s+st" ① | 6 ... 3/0 AWG

Terminal block width: 20.5 mm / 0.807 inch

 22 mm / 0.87 inch

Tightening torque: 6 ... 12 Nm

Screw thread: M8

Actuation type: T-wrench; 6 mm

Insulation material: Polyamide 66 (PA66)

Flammability class UL 94: V0

Continuous operating temperature: -35 ... +105 °C

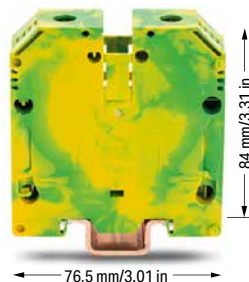

2-conductor ground terminal block; only suitable for DIN 35 x 15 rail; 2.3 mm thick; copper

Color	Item No.	PU
 green-yellow	883-7007	10

### Item-Specific Accessories

#### Protective warning marker; with high-voltage symbol

	yellow	883-7086	10
	white	883-7088	10

#### Insertion plate for flat cables

	uninsulated	883-7099	10
---	-------------	----------	----

#### Screwless end stop; for DIN-35 rail; 10 mm wide

	gray	249-117	50 (25)
---	------	---------	---------

#### Screwless end stop; for DIN-35 rail; 14 mm wide

	gray	249-197	10
---	------	---------	----

### Technical Data

Nominal cross-section: 10 mm<sup>2</sup>

0.2 ... 10 mm<sup>2</sup> "s+st+f-st" ② | 22 ... 8 AWG

1000 V/6 kV/3 ③

I<sub>N</sub> 57 A

Module width: 10 mm / 0.39 inch

 12 mm / 0.47 inch

Tightening torque: 1.2 ... 2 Nm

Screw thread: M4

Actuation type: Slot screwdriver; (4 x 0.8) mm blade

Insulation material: Polyamide 66 (PA66)

Flammability class UL 94: V2

Continuous operating temperature: -35 ... +105 °C



Power tap

Color	Item No.	PU
 beige	883-7030	10

① Conductor range: 10 ... 95 mm<sup>2</sup> "s+st"; 10 ... 70 mm "f-st";  
Insulated ferrules: 10 ... 70 mm<sup>2</sup>

② Conductor range: 0.2 ... 10 mm<sup>2</sup> "s+st+f-st";  
Insulated ferrules: 0.2 ... 10 mm<sup>2</sup>

③ 1000 V = rated voltage  
8 kV = rated impulse voltage  
3 = pollution degree

Approvals and corresponding ratings,  
visit [www.wago.com](http://www.wago.com)



#### Commoning

Step 1: Remove the inner partitions at the defined break points.



#### Power tap

The power tap is inserted into the slot above the conductor entry and pressed indirectly against the current bar via the clamping bracket when the clamping point is actuated.



#### Mounting and removing through terminal blocks

Mounting is performed by simply snapping the terminal block onto the DIN-rail. The pins in the housing ensure an increased mechanical stability in the terminal block assembly when the rail-mount terminal blocks are pushed together.

Removal is performed by pushing back one of the locking elements on both sides and simultaneously tilting it off the DIN-rail.



#### Commoning

Step 2: Insert the jumper into the jumper slot and tighten the screws with a slotted screwdriver. The jumpers are designed for the rated current of the screw terminal block.



#### Insertion plate

To connect flat cables, the insertion plates are mounted into the clamping bracket to compensate for the V-shaped geometry and provide a secure conductor connection.



#### Mounting and removing ground conductor terminal blocks

Installation is performed by placing the ground conductor terminal block on the copper DIN-rail and then securing it by tightening the Allen screw in the jumper slot with a torque of 2.5...4 Nm.

A 4 mm Allen key is used to tighten the screw.

Removal is performed by loosening the Allen screw in the jumper slot and tilting it off the DIN-rail.



#### Protective warning marker

The warning covers marked with a lightning arrow are snapped onto the screw terminal block from above and close the actuation slot. This prevents actuation of the clamping point under voltage and guarantees protection against accidental contact.



#### Marking

The screw terminal blocks can be labeled quickly and easily with the WMB Inline marking system. The markers are inserted into the receptacles provided for this purpose. The 2009-198 Marker Carrier allows marking strips to be used.

For marking accessories, see pages 24 and 25.

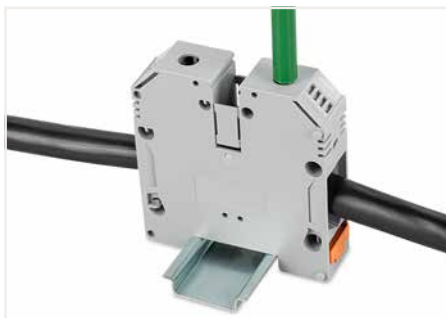

#### Conductor termination and clamping point actuation

The stripped conductor is inserted into the clamping unit until it hits the backstop. By turning the screw to the right with a 6 mm T-wrench, the conductor is indirectly pressed against the current bar via the clamping bracket.



#### Testing

Voltage measurements can be performed via the screw heads in the actuation slot (e.g., via 2-pole 206-707 Voltage Tester).

## Through Terminal Block, Power Tap; with Screw Connection 883 Series

### Technical Data

Nominal cross-section: 120 mm<sup>2</sup>

16 ... 150 mm<sup>2</sup> "s+st" ① | 4 ... 4/0 AWG

1000 V/8 kV/3 ③ | 600 V, 228 A 

I<sub>N</sub> 269 A (290 A) | 600 V, 228 A 

Terminal block width: 27 mm / 1.063 inch

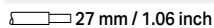
 27 mm / 1.06 inch

Tightening torque: 12 ... 20 Nm

Screw thread: M10

Actuation type: T-wrench; 6 mm



Insulation material: Polyamide 66 (PA66)

Flammability class UL 94: V0

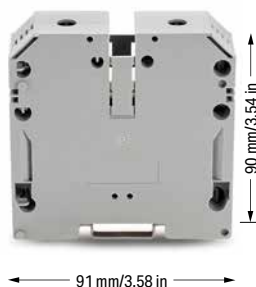
Continuous operating temperature: -35 ... +105 °C



### 2-conductor through terminal block

Color	Item No.	PU
 gray	883-1201	5
 blue	883-1204	5



### Item-Specific Accessories

#### Jumper bar; uninsulated



2-way	883-1242	10
3-way	883-1243	10
4-way	883-1244	10

#### Protective warning marker; with high-voltage symbol

 yellow	883-1286	10
 white	883-1288	10

#### Insertion plate for flat cables

 uninsulated	883-1299	10
--	----------	----

#### Screwless end stop; for DIN-35 rail; 10 mm wide

 gray	249-117	50 (25)
---	---------	---------

#### Screwless end stop; for DIN-35 rail; 14 mm wide

 gray	249-197	10
---	---------	----

### Technical Data

Nominal cross-section: 10 mm<sup>2</sup>

0.2 ... 10 mm<sup>2</sup> "s+st+f-st" ② | 22 ... 8 AWG

1000 V/6 kV/3 ③

I<sub>N</sub> 57 A

Module width: 10 mm / 0.39 inch

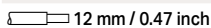
 12 mm / 0.47 inch

Tightening torque: 1.2 ... 2 Nm

Screw thread: M4

Actuation type: Slot screwdriver; (4 x 0.8) mm blade

Insulation material: Polyamide 66 (PA66)

Flammability class UL 94: V2

Continuous operating temperature: -35 ... +105 °C

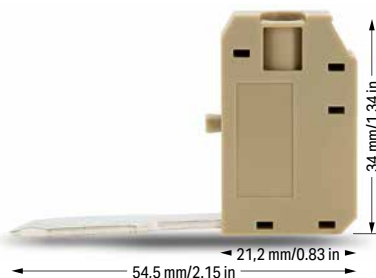

### Power tap

Color	Item No.	PU
 beige	883-1230	10

① Conductor range: 16 ... 150 mm<sup>2</sup> "s+st"; 16 ... 120 mm "f-st";  
Insulated ferrules: 16 ... 95 mm<sup>2</sup>

② Conductor range: 0.2 ... 10 mm<sup>2</sup> "s+st+f-st";  
Insulated ferrules: 0.2 ... 10 mm<sup>2</sup>

③ 1000 V = rated voltage  
8 kV = rated impulse voltage  
3 = pollution degree

Approvals and corresponding ratings,  
visit [www.wago.com](http://www.wago.com)



#### Mounting and removing through terminal blocks

Mounting is performed by simply snapping the terminal block onto the DIN-rail. The pins in the housing increase mechanical stability in the terminal block assembly when the rail-mount terminal blocks are pushed together. Removal is performed by pushing back one of the locking elements on both sides and simultaneously tilting it off the DIN-rail.



#### Commoning

Step 1: Remove the inner partitions at the defined break points (a cutting tool may be required to cut off the partitions).



#### Insertion plate

To connect flat cables, the insertion plates are mounted into the clamping bracket to compensate for the V-shaped geometry and provide a secure conductor connection.



#### Conductor termination and clamping point actuation

The stripped conductor is inserted into the clamping unit until it hits the backstop. By turning the screw to the right with a 6 mm T-wrench, the conductor is indirectly pressed against the current bar via the clamping bracket.

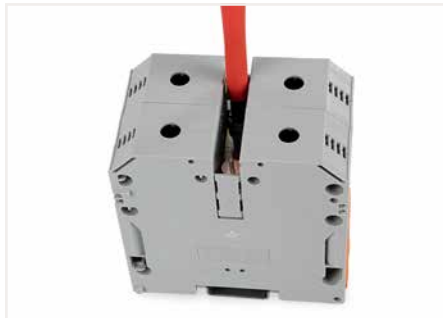

#### Commoning

Step 2: Insert the jumper into the jumper slot and tighten the screws with a slotted screwdriver. The jumpers are designed for the rated current of the screw terminal block.



#### Marking

The screw terminal blocks can be labeled quickly and easily with the WMB Inline marking system. The markers are inserted into the receptacles provided for this purpose. The 2009-198 Marker Carrier allows marking strips to be used.

For marking accessories, see pages 24 and 25.



#### Protective warning marker

The warning covers marked with a lightning arrow are snapped onto the screw terminal block from above and close the actuation slot. This safeguard prevents actuation of the clamping point under voltage and guarantees protection against accidental contact.

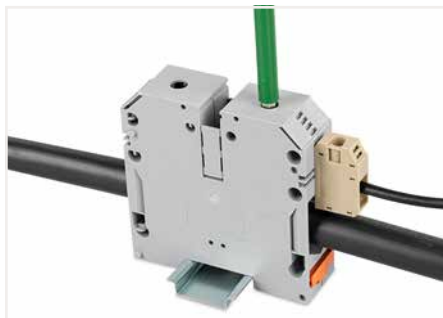

#### Power tap

The power tap is inserted into the slot above the conductor entry and pressed indirectly against the current bar via the clamping bracket when the clamping point is actuated.



#### Testing

Voltage measurements can be performed via the screw heads in the actuation slot (e.g., via 2-pole 206-707 Voltage Tester).

## Through Terminal Block, Power Tap; with Screw Connection 883 Series

### Technical Data

Nominal cross-section: 240 mm<sup>2</sup>

70 ... 240 mm<sup>2</sup> "s+st+f-st" | 2/0 AWG ... 500 kcmil

①

1000 V/8 kV/3 ③ | 600 V, 370 A

I<sub>N</sub> 380 A | 600 V, 370 A

Terminal block width: 36 mm / 1.417 inch

38 mm / 1.5 inch

Tightening torque: 10 ... 20 Nm

Screw thread: M10

Actuation type: T-wrench; 8 mm

Insulation material: Polyamide 66 (PA66)

Flammability class UL 94: V2

Continuous operating temperature: -35 ... +105 °C

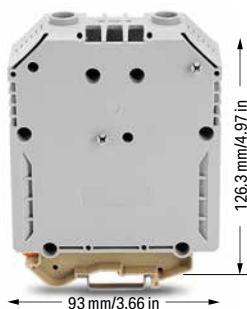

### 2-conductor through terminal block

Color	Item No.	PU
○ gray	883-2401	5
● blue	883-2404	5

### Item-Specific Accessories

#### Jumper; yellow

	2-way	883-2442	5
	3-way	883-2443	5

#### Protective warning marker; with high-voltage symbol

	yellow	883-2486	20
--	--------	----------	----

#### Insertion plate for flat cables

	uninsulated	883-2499	10
--	-------------	----------	----

#### Screwless end stop; for DIN-35 rail; 14 mm wide

	gray	249-197	10
--	------	---------	----

### Technical Data

Nominal cross-section: 10 mm<sup>2</sup>

0.2 ... 10 mm<sup>2</sup> "s+st+f-st" ② | 22 ... 8 AWG

1000 V/6 kV/3 ③

I<sub>N</sub> 57 A

Module width: 10 mm / 0.39 inch

12 mm / 0.47 inch

Tightening torque: 1.2 ... 2 Nm

Screw thread: M4

Actuation type: Slot screwdriver; (4 x 0.8) mm blade

Insulation material: Polyamide 66 (PA66)

Flammability class UL 94: V2

Continuous operating temperature: -35 ... +105 °C



### Power tap

Color	Item No.	PU
● beige	883-1230	10

① Conductor range: 70 ... 240 mm<sup>2</sup> "s+st+f-st";  
Insulated ferrules: 70 ... 185 mm<sup>2</sup>

② Conductor range: 0.2 ... 10 mm<sup>2</sup> "s+st+f-st";  
Insulated ferrules: 0.2 ... 10 mm<sup>2</sup>

③ 1000 V = rated voltage  
8 kV = rated impulse voltage  
3 = pollution degree

Approvals and corresponding ratings,  
visit [www.wago.com](http://www.wago.com)



**Mounting and removing through terminal blocks**  
 Mounting is performed by simply snapping the terminal block onto the DIN-rail. The fixed snap-in foot is put on first.  
 Removal is performed by pushing back the movable snap-in foot and simultaneously tilting it off the rail.



**Commoning**  
 Step 1: Insert the 2- or 3-way jumper into the conductor entry to connect adjacent terminal blocks.



**Power tap**  
 The power tap is inserted into the slot above the conductor entry. The power tap is pressed indirectly against the current bar via the clamping bracket when the clamping point is actuated.



**Conductor termination and clamping point actuation**  
 The stripped conductor is inserted into the clamping unit until it hits the backstop. By turning the screw to the right with a 8 mm T-wrench, the conductor is indirectly pressed against the current bar via the clamping bracket.

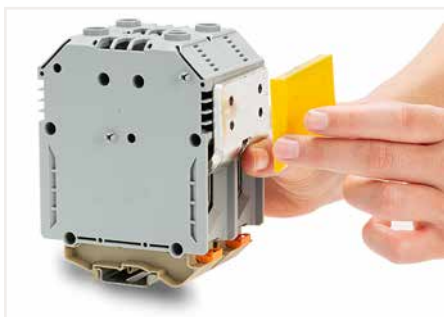

**Commoning**  
 Step 2: Mount the yellow insulating cap and snap it to the housing to position the jumper in the clamping unit.



**Insertion plate**  
 To connect flat cables, the insertion plates are mounted into the clamping bracket to compensate for the V-shaped geometry and provide a secure conductor connection.



**Protective warning marker**  
 The warning covers marked with a lightning arrow are snapped onto the screw terminal block from above and close the actuation slot. This prevents actuation of the clamping point under voltage and guarantees protection against accidental contact.



**Commoning**  
 Step 3: By tightening the screw in the actuation slot, the jumper is secured in the conductor entry. If required, a conductor can also be inserted into the conductor entry and clamped together with the jumper.  
 A multiple potential distribution is possible due to the conductor entry on both sides. The jumpers are designed for the rated current of the screw terminal block.



**Marking**  
 The screw terminal blocks can be labeled quickly and easily with the WMB Inline marking system. The markers are inserted into the receptacles provided for this purpose. The 2009-198 Marker Carrier allows marking strips to be used.  
 For marking accessories, see pages 24 and 25.



**Testing**  
 Voltage measurements can be performed via the screw heads in the actuation slot (e.g. via 2-pole 206-707 Voltage Tester).

# STUD TERMINAL BLOCKS

## 884 Series

### Connection Stud

- Stud for mounting ring cable lugs

### Receptacle for Covers

- Covers guarantee a safe operation

### Commoning

- Both sides can be commoned with jumpers
- Remove the partitions before inserting the jumpers

### Snap-In Mounting Foot for DIN-35 Rails

- Snap onto the DIN-rail on both sides

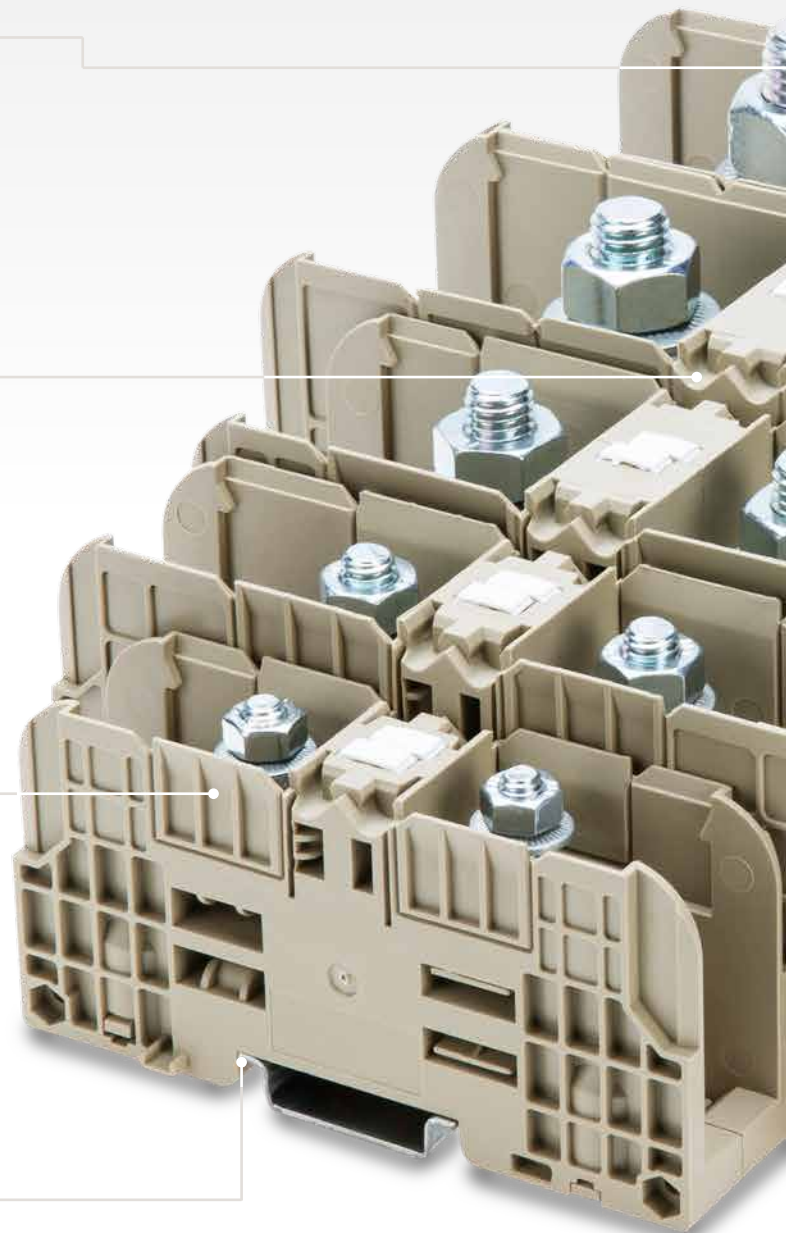

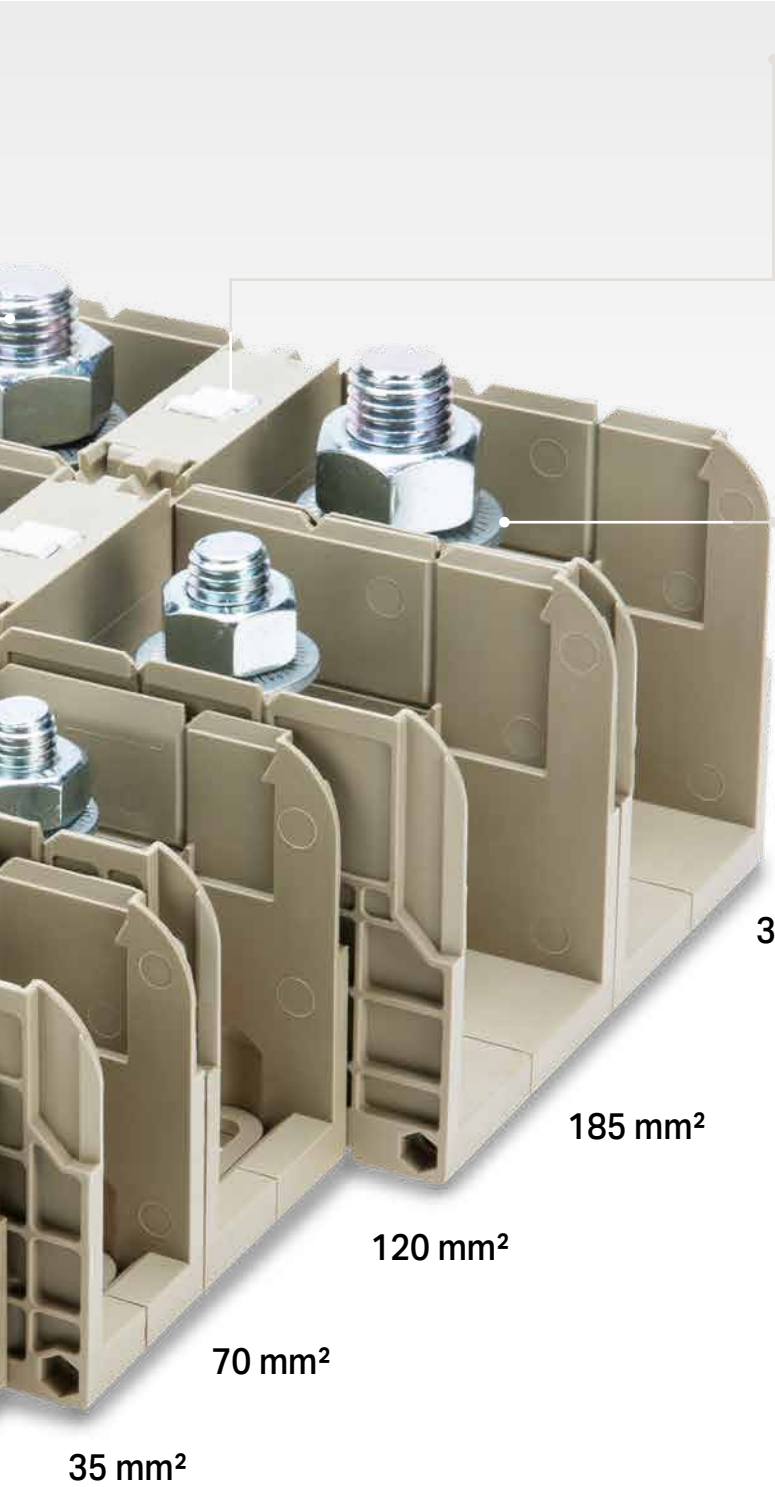

### Marking

- WMB
- WMB Inline
- Mini-WSB
- Mini-WSB Inline
- Marker carrier for marking strips

### Conductor Entry

- Lateral conductor entry
- Top mounting of the ring cable lug

300 mm<sup>2</sup>

185 mm<sup>2</sup>

120 mm<sup>2</sup>

70 mm<sup>2</sup>

35 mm<sup>2</sup>

## Stud Terminal Block 884 Series

### Technical Data

Nominal cross-section: 35 mm<sup>2</sup>

2.5 ... 50 mm<sup>2</sup> ① | 14 ... 1/0 AWG

1000 V/8 kV/3 ② | 1000 V, 130 A ③

I<sub>N</sub> 125 A | 1000 V, 130 A ④

Terminal block width: 27 mm / 1.063 inch

Tightening torque: 3 ... 6 Nm

Thread size: M6

Actuation type: Open-end, ring, socket wrench; 10 mm

Insulation material: Polyamide 66 (PA66)

Flammability class UL 94: V0

Continuous operating temperature: -35 ... +105 °C



107 mm / 4.21 in

Stud terminal block; with two M6 studs

Color	Item No.	PU
● beige	884-3500	10

### Item-Specific Accessories

Jumper; for M6 studs; uninsulated

●	2-way	884-3542	10
●	3-way	884-3543	10

Cover; for 35 mm<sup>2</sup> stud terminal blocks

●	beige	884-3580	10
●	blue	884-3584	10
●	yellow	884-3586	10

### Technical Data

Nominal cross-section: 70 mm<sup>2</sup>

2.5 ... 95 mm<sup>2</sup> ② | 14 ... 3/0 AWG

1000 V/8 kV/3 ③ | 1000 V, 175 A ④

I<sub>N</sub> 192 A (232 A) | 1000 V, 175 A ⑤

Terminal block width: 32 mm / 1.26 inch

Tightening torque: 6 ... 12 Nm

Thread size: M8

Actuation type: Open-end, ring, socket wrench; 13 mm

Insulation material: Polyamide 66 (PA66)

Flammability class UL 94: V0

Continuous operating temperature: -35 ... +105 °C



132 mm / 5.2 in

Stud terminal block; with two M8 studs

Color	Item No.	PU
● beige	884-7000	10

### Item-Specific Accessories

Jumper; for M8 studs; uninsulated

●	2-way	884-7042	10
●	3-way	884-7043	10

Cover; for 70 mm<sup>2</sup> stud terminal blocks

●	beige	884-7080	10
●	blue	884-7084	10
●	yellow	884-7086	10

### Technical Data 10 AWG ... 250 kcmil

Nominal cross-section: 120 mm<sup>2</sup>

6 ... 120 mm<sup>2</sup> ③ | 10 AWG ... 250 kcmil

1000 V/8 kV/3 ④ | 1000 V, 225 (310) A ⑤

I<sub>N</sub> 269 A (290 A) | 1000 V, 310 A ⑥

Terminal block width: 42 mm / 1.654 inch

Tightening torque: 10 ... 20 Nm

Thread size: M10

Actuation type: Open-end, ring, socket wrench; 17 mm

Insulation material: Polyamide 66 (PA66)

Flammability class UL 94: V0

Continuous operating temperature: -35 ... +105 °C



133 mm / 5.24 in

Stud terminal block; with two M10 studs

Color	Item No.	PU
● beige	884-1200	5

### Item-Specific Accessories

Jumper; for M10 studs; uninsulated

●	2-way	884-1242	10
●	3-way	884-1243	10

Cover; for 120 mm<sup>2</sup> stud terminal blocks

●	beige	884-1280	10
●	blue	884-1284	10
●	yellow	884-1286	10



### Assembly and removal

Mounting is performed by simply snapping the terminal block onto the DIN-rail. Locking devices are provided on both sides. Removal is performed by pushing back a locking device and simultaneously tilting it off the rail. The slotted holes in the bottom of the housing allow direct screw mounting on suitable surfaces.



### Commoning

Step 1: Remove the inner partitions next to the studs.  
Step 2: Place the 2- or 3-way jumper on the studs to be connected.  
Step 3: Tighten the hex flange nuts to the required torque.  
Notice: The jumpers are positioned under the ring cable lug to be connected.  
The jumpers are designed for the rated current of the respective stud terminal block.

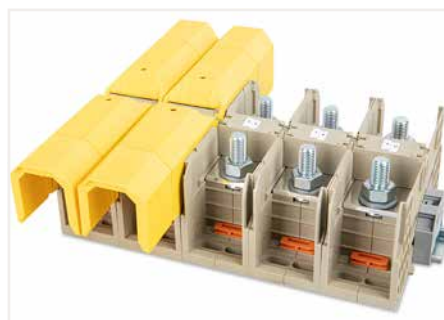

### Cover

The covers are snapped from the top into the provided locking mechanism of the stud terminal block. The covers can be shortened with a cutting tool. The covers can be mounted on one or both sides and ensure reliable protection against contact.

**Technical Data**

Nominal cross-section: 185 mm<sup>2</sup>  
 10 ... 185 mm<sup>2</sup> ④ | 8 AWG ... 500 kcmil  
 1000 V/8 kV/3 ⑥ | 1000 V, 380 A **VA**  
 I<sub>N</sub> 353 A | 1000 V, 380 A **Ⓢ**  
 Terminal block width: 55 mm / 2.165 inch  
 Tightening torque: 14 ... 31 Nm  
 Thread size: M12  
 Actuation type: Open-end, ring, socket wrench; 19 mm  
 Insulation material: Polyamide 66 (PA66)  
 Flammability class UL 94: V0  
 Continuous operating temperature: -35 ... +105 °C

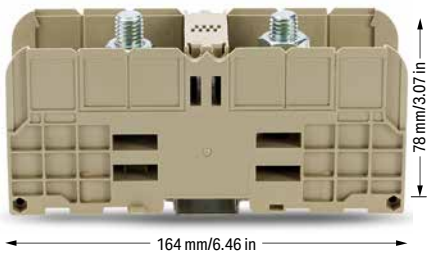



**Stud terminal block; with two M12 studs**

Color	Item No.	PU
● beige	884-1800	5

**Item-Specific Accessories**

**Jumper; for M12 studs; uninsulated**

	2-way	884-1842	10
	3-way	884-1843	10

**Cover; for 185 mm<sup>2</sup> stud terminal blocks**

	beige	884-3080	10
	blue	884-3084	10
	yellow	884-3086	10

**Technical Data**

Nominal cross-section: 300 mm<sup>2</sup>  
 25 ... 300 mm<sup>2</sup> ⑤ | 6 AWG ... 600 kcmil  
 1000 V/8 kV/3 ⑥ | 1000 V, 420 (510) A **VA**  
 I<sub>N</sub> 520 A | 1000 V, 510 A **Ⓢ**  
 Terminal block width: 55 mm / 2.165 inch  
 Tightening torque: 25 ... 60 Nm  
 Thread size: M16  
 Actuation type: Open-end, ring, socket wrench; 24 mm  
 Insulation material: Polyamide 66 (PA66)  
 Flammability class UL 94: V0  
 Continuous operating temperature: -35 ... +105 °C

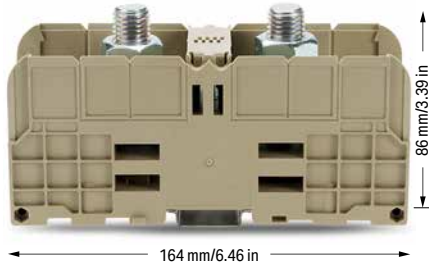



**Stud terminal block; with two M16 studs**

Color	Item No.	PU
● beige	884-3000	5

**Item-Specific Accessories**

**Jumper; for M16 studs; uninsulated**

	2-way	884-3042	10
	3-way	884-3043	10

**Cover; for 300 mm<sup>2</sup> stud terminal blocks**

	beige	884-3080	10
	blue	884-3084	10
	yellow	884-3086	10

① Conductor cross-section  
 DIN 46234: 1 cable lug per side: 2.5 ... 50 mm<sup>2</sup>  
 DIN 46235: 1 cable lug per side: 6 ... 25 mm<sup>2</sup>

② Conductor cross-section  
 DIN 46234: 1 cable lug per side: 2.5 ... 95 mm<sup>2</sup>  
 DIN 46235: 1 cable lug per side: 16 ... 70 mm<sup>2</sup>

③ Conductor cross-section  
 DIN 46234: 1 cable lug per side: 6 ... 150 mm<sup>2</sup>  
 DIN 46234: 2 cable lugs per side: 6 ... 120 mm<sup>2</sup>  
 DIN 46235: 1 cable lug per side: 16 ... 150 mm<sup>2</sup>  
 DIN 46235: 2 cable lugs per side: 16 ... 120 mm<sup>2</sup>

④ Conductor cross-section  
 DIN 46234: 1 cable lug per side: 10 ... 240 mm<sup>2</sup>  
 DIN 46234: 2 cable lugs per side: 10 ... 185 mm<sup>2</sup>  
 DIN 46235: 1 cable lug per side: 25 ... 240 mm<sup>2</sup>  
 DIN 46235: 2 cable lugs per side: 25 ... 185 mm<sup>2</sup>

⑤ Conductor cross-section  
 DIN 46234: 1 cable lug per side: 25 ... 240 mm<sup>2</sup>  
 DIN 46234: 2 cable lugs per side: 50 ... 240 mm<sup>2</sup>  
 DIN 46235: 1 cable lug per side: 50 ... 300 mm<sup>2</sup>  
 DIN 46235: 2 cable lugs per side: 50 ... 240 mm<sup>2</sup>

⑥ 1000 V = rated voltage  
 8 kV = rated impulse voltage  
 3 = pollution degree

Please observe the application notes of the cable lug manufacturers regarding the strip length and the appropriate conductor cross sections.

Type of cable lugs per DIN 46234:  
 Cable lugs for solder-free connections  
 Ring type, without insulating sleeve, for copper conductors

Type of cable lugs per DIN 46235:  
 Cable lugs for compression connections  
 Cover plate type for copper conductors

Approvals and corresponding ratings, visit [www.wago.com](http://www.wago.com)



**Testing**  
 Voltage measurements can be performed directly on the studs. Thanks to the provided test slots, voltage measurements are also possible with mounted warning covers.



**Marking**  
 The stud terminal blocks can be labeled quickly and easily with the WMB In-line marking system. The markers are inserted into the receptacles provided for this purpose. The 2009-198 Marker Carrier allows marking strips to be used.  
 For marking accessories, see pages 24 and 25.



**Connecting two cable lugs to a stud**  
 Up to two cable lugs can be connected to one stud. For this purpose, the cable lugs are placed back-to-back on the stud.  
 Then the hex flange nut is tightened with the required torque so that the lugs of the cable lugs press against each other and make secure contact with the current bar.

## Stud Terminal Blocks

### 885 Series

#### Description and Installation



Assembly options – just snap cover in at the required position.



Touch guard cover – can be secured against slipping via clip. The hole must be drilled in the appropriate position (6 mm drilled hole diameter).

When mounting the cover to the outer positions, drill the hole for the clip between the marker slots into the cover. Insert the pins of the clip into the drilled hole one after the other (6 mm drilled hole diameter).



Fast and easy potential distribution using jumpers – 2-way jumper from M10 to M10 via separator



Step-down jumper from M8 to M6

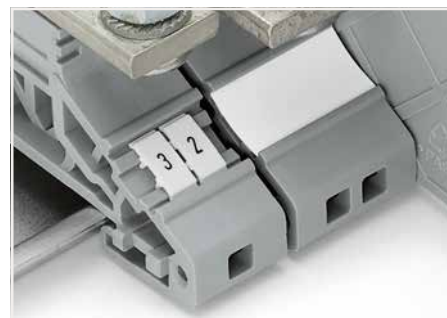
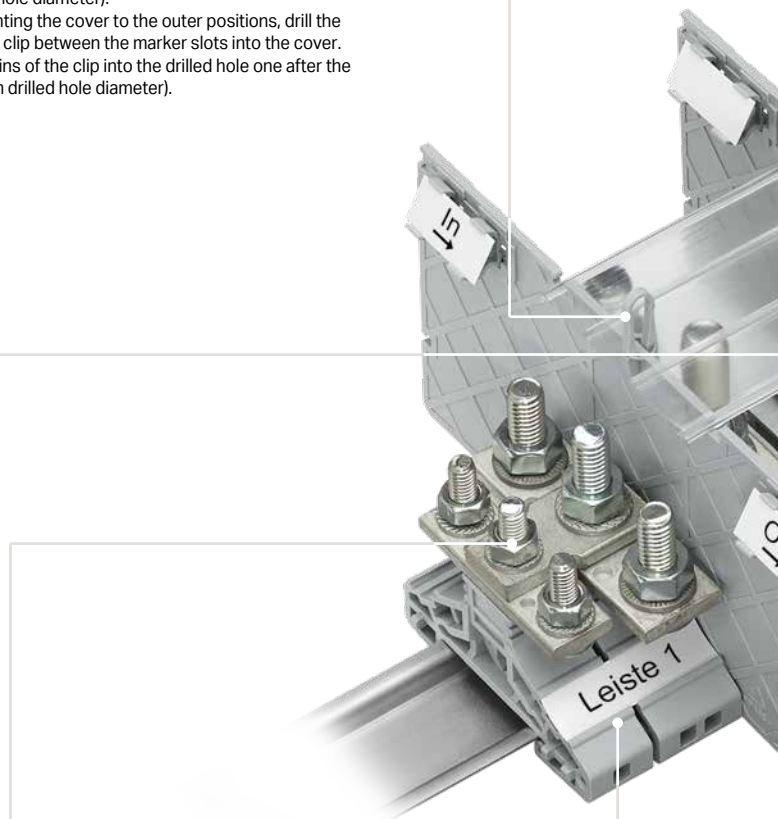

Terminal block marking – either with WMB marker or marking strips



Empty housing as placeholder (M10)

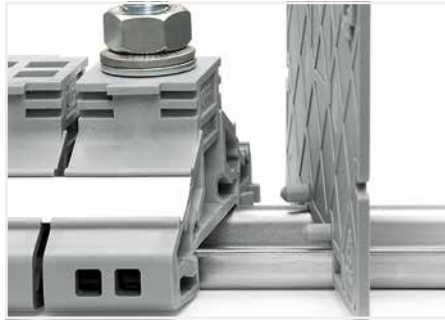

Securing a separator plate on a stud terminal block via guide pins.

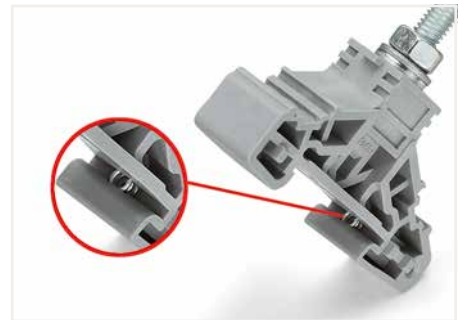

First, mount the terminal base over the edge for fitting onto the DIN-rail.

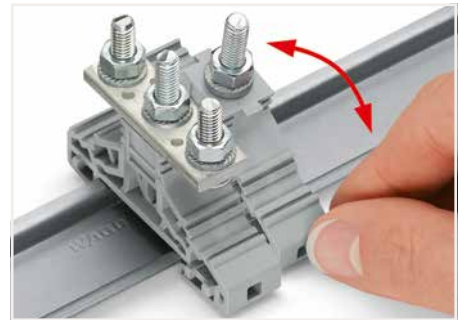
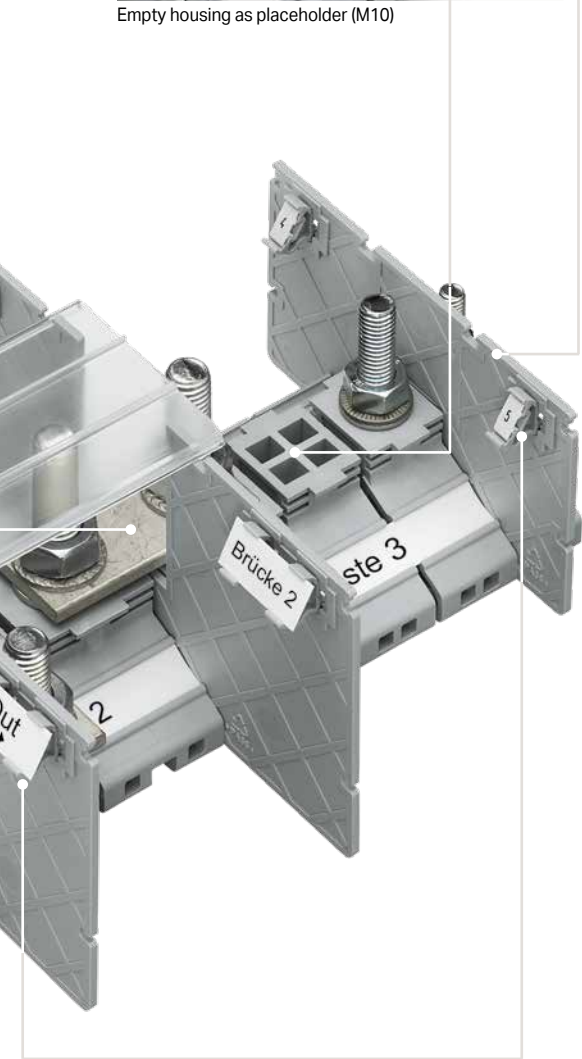

Then, slide the terminal side with the spring element toward the center of the rail and alternately press it up/down.

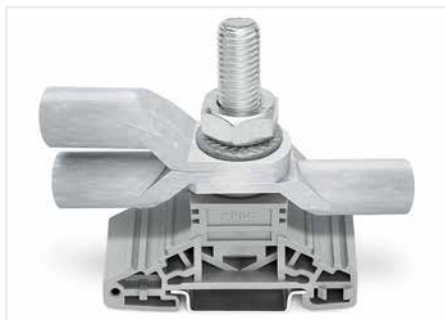

Up to three cable lugs can be connected according to:

- DIN 46234  
Cable lugs for solder-free connections, ring type, without insulating sleeve, for copper conductors and
- DIN 46235  
Cable lugs for compression connections, cover plate type for copper conductors

Install cable lugs back-to-back on the stud. Then, tighten to the required torque using a nut secured by a lock washer.

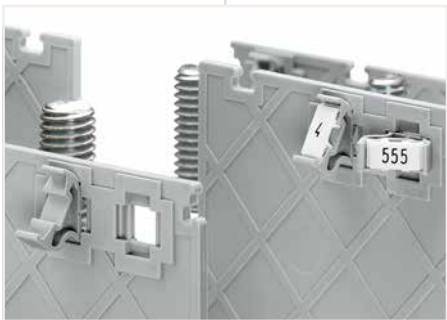

Group marking with marker carrier – either via WMB marker or marking strip

## Stud Terminal Block 885 Series

### Technical Data

Nominal cross-section: 35 mm<sup>2</sup>

2.5 ... 35 mm<sup>2</sup> ① | 14 ... 1/0 AWG

1000 V/8 kV/3 ④ | 600 V, 115 A ⑧

I<sub>N</sub> 125 A | 600 V, 115 A ⑥

Terminal block width: 17.8 mm / 0.917 inch

Tightening torque: 3 ... 6 Nm

Thread size: M6

Actuation type: Open-end, ring, socket wrench; 10 mm

Insulation material: Polyamide 66 (PA66)

Flammability class UL 94: V0

Continuous operating temperature: -35 ... +105 °C

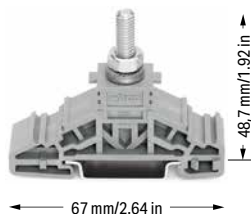

### Technical Data

Nominal cross-section: 50 mm<sup>2</sup>

2.5 ... 50 mm<sup>2</sup> ② | 14 ... 1/0 AWG

1000 V/8 kV/3 ④ | 600 V, 150 A ⑧

I<sub>N</sub> 150 A | 600 V, 150 A ⑥

Terminal block width: 22.8 mm / 0.898 inch

Tightening torque: 6 ... 12 Nm

Thread size: M8

Actuation type: Open-end, ring, socket wrench; 13 mm

Insulation material: Polyamide 66 (PA66)

Flammability class UL 94: V0

Continuous operating temperature: -35 ... +105 °C

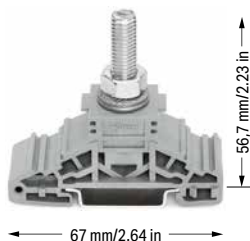

### Technical Data

Nominal cross-section: 120 mm<sup>2</sup>

6 ... 120 mm<sup>2</sup> ③ | 10 AWG ... 250 kcmil

1000 V/8 kV/3 ④ | 600 V, 255 A ⑧

I<sub>N</sub> 269 A | 600 V, 255 A ⑥

Terminal block width: 33.8 mm / 1.331 inch

Tightening torque: 10 ... 20 Nm

Thread size: M10

Actuation type: Open-end, ring, socket wrench; 17 mm

Insulation material: Polyamide 66 (PA66)

Flammability class UL 94: V0

Continuous operating temperature: -35 ... +105 °C

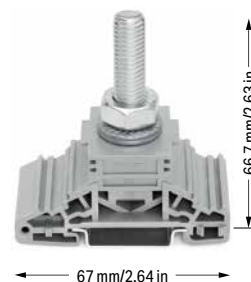

### Stud terminal block; 1 stud, M6

Color	Item No.	PU
○ gray	885-106	25

### Item-Specific Accessories

#### Separator plate; 2 mm thick; 102.3 mm wide

	gray	885-526	25
---	------	---------	----

#### Separator plate with jumper slot; 2 mm thick; 102.3 mm wide

	gray	885-546	25
---	------	---------	----

### Jumper

	2-way	885-406	5
	3-way	885-426	5

### Empty housing; 17.8 mm thick

	gray	885-506	25
---	------	---------	----

### Cover; 1 m long

	transparent	885-566	1
--	-------------	---------	---

### Clip; secures cover against slipping

	gray	885-580	100 (25)
--	------	---------	----------

### Stud terminal block; 1 stud, M8

Color	Item No.	PU
○ gray	885-108	25

### Item-Specific Accessories

#### Separator plate; 2 mm thick; 110.3 mm wide

	gray	885-528	25
---	------	---------	----

#### Separator plate with jumper slot; 2 mm thick; 110.3 mm wide

	gray	885-548	25
---	------	---------	----

### Jumper; 2-way

	2-way	885-408	5
	3-way	885-428	5

### Step-down jumper; from M8 to M6

		885-448	5
---	--	---------	---

### Empty housing; 22.8 mm thick

	gray	885-508	20
---	------	---------	----

### Cover; 1 m long

	transparent	885-566	1
---	-------------	---------	---

### Clip; secures cover against slipping

	gray	885-580	100 (25)
---	------	---------	----------

### Stud terminal block; 1 stud, M10

Color	Item No.	PU
○ gray	885-110	20

### Item-Specific Accessories

#### Separator plate; 2 mm thick; 157 mm wide

	gray	885-530	25
---	------	---------	----

#### Separator plate with jumper slot; 2 mm thick; 157 mm wide

	gray	885-550	25
---	------	---------	----

### Jumper; 2-way

	2-way	885-410	5
	3-way	885-430	5

### Step-down jumper; from M10 to M6

		885-470	5
---	--	---------	---

### Empty housing; 33.8 mm thick

	gray	885-510	20
---	------	---------	----

### Cover; 1 m long

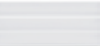
	transparent	885-570	1
---	-------------	---------	---

### Clip; secures cover against slipping

	gray	885-580	100 (25)
---	------	---------	----------

**Technical Data**Nominal cross-section: 120 mm<sup>2</sup>6 ... 120 mm<sup>2</sup> ③ | 10 AWG ... 250 kcmil

1000 V/8 kV/3 ④ | 600 V, 255 A ①

I<sub>N</sub> 269 A | 600 V, 255 A ②

Terminal block width: 33.8 mm / 1.331 inch

Tightening torque: 10 ... 20 Nm

Thread size: M12

Actuation type: Open-end, ring, socket wrench; 19 mm

Insulation material: Polyamide 66 (PA66)

Flammability class UL 94: V0

Continuous operating temperature: -35 ... +105 °C

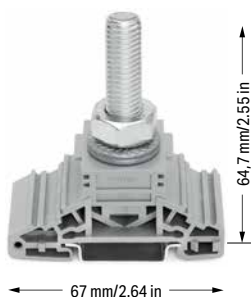

① Conductor cross-section  
 DIN 46234: 1 cable lug per side: 2.5 ... 35 mm<sup>2</sup>  
 DIN 46234: 2 cable lugs per side: 2.5 ... 35 mm<sup>2</sup>  
 DIN 46235: 1 cable lug per side: 6 ... 25 mm<sup>2</sup>  
 DIN 46235: 2 cable lugs per side: 6 ... 25 mm<sup>2</sup>

② Conductor cross-section  
 DIN 46234: 1 cable lug per side: 2.5 ... 50 mm<sup>2</sup>  
 DIN 46234: 2 cable lugs per side: 2.5 ... 50 mm<sup>2</sup>  
 DIN 46235: 1 cable lug per side: 6 ... 35 mm<sup>2</sup>  
 DIN 46235: 2 cable lugs per side: 6 ... 35 mm<sup>2</sup>

③ Conductor cross-section  
 DIN 46234: 1 cable lug per side: 6 ... 120 mm<sup>2</sup>  
 DIN 46234: 2 cable lugs per side: 6 ... 120 mm<sup>2</sup>  
 DIN 46235: 1 cable lug per side: 10 ... 95 mm<sup>2</sup>  
 DIN 46235: 2 cable lugs per side: 10 ... 95 mm<sup>2</sup>

④ 1000 V = rated voltage  
 8 kV = rated impulse voltage  
 3 = pollution degree

Please observe the application notes of the cable lug manufacturers regarding the strip length and the appropriate conductor cross sections.

Approvals and corresponding ratings, visit [www.wago.com](http://www.wago.com)

**Stud terminal block; 1 stud, M12**

Color	Item No.	PU
○ gray	885-112	20

**Item-Specific Accessories****Separator plate; 2 mm thick; 157 mm wide**

 gray	885-530	25
--	---------	----

**Separator plate with jumper slot; 2 mm thick; 157 mm wide**

 gray	885-550	25
--	---------	----

**Jumper; 2-way**

 2-way	885-412	5
 3-way	885-432	5

**Empty housing; 33.8 mm thick**

 gray	885-510	20
--	---------	----

**Cover; 1 m long**

 transparent	885-570	1
---	---------	---

**Clip; secures cover against slipping**

 gray	885-580	100 (25)
--	---------	----------

## Stud Terminal Block 885 Series

### Technical Data

Nominal cross-section: 35 mm<sup>2</sup>

2.5 ... 35 mm<sup>2</sup> ① | 14 ... 1/0 AWG

1000 V/8 kV/3 ④ | 600 V, 115 A ⑤

I<sub>N</sub> 125 A | 600 V, 115 A ⑥

Terminal block width: 17.8 mm / 0.917 inch

Tightening torque: 3 ... 6 Nm

Thread size: M6

Actuation type: Open-end, ring, socket wrench; 10 mm

Insulation material: Polyamide 66 (PA66)

Flammability class UL 94: V0

Continuous operating temperature: -35 ... +105 °C



### Technical Data

Nominal cross-section: 50 mm<sup>2</sup>

2.5 ... 50 mm<sup>2</sup> ② | 14 ... 1/0 AWG

1000 V/8 kV/3 ④ | 600 V, 150 A ⑤

I<sub>N</sub> 150 A | 600 V, 150 A ⑥

Terminal block width: 22.8 mm / 0.898 inch

Tightening torque: 6 ... 12 Nm

Thread size: M8

Actuation type: Open-end, ring, socket wrench; 13 mm

Insulation material: Polyamide 66 (PA66)

Flammability class UL 94: V0

Continuous operating temperature: -35 ... +105 °C

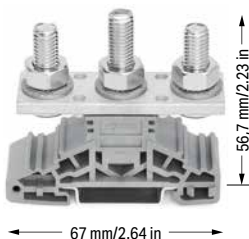

### Technical Data

Nominal cross-section: 120 mm<sup>2</sup>

6 ... 120 mm<sup>2</sup> ③ | 10 AWG ... 250 kcmil

1000 V/8 kV/3 ④ | 600 V, 255 A ⑤

I<sub>N</sub> 269 A | 600 V, 255 A ⑥

Terminal block width: 33.8 mm / 1.331 inch

Tightening torque: 10 ... 20 Nm

Thread size: M10

Actuation type: Open-end, ring, socket wrench; 17 mm

Insulation material: Polyamide 66 (PA66)

Flammability class UL 94: V0

Continuous operating temperature: -35 ... +105 °C



### Stud terminal block; 3 studs; M6

Color	Item No.	PU
○ gray	885-306	25

### Item-Specific Accessories

#### Separator plate; 2 mm thick; 102.3 mm wide

	gray	885-526	25
---	------	---------	----

#### Separator plate with jumper slot; 2 mm thick; 102.3 mm wide

	gray	885-546	25
---	------	---------	----

### Jumper

	2-way	885-406	5
	3-way	885-426	5

### Empty housing; 17.8 mm thick

	gray	885-506	25
---	------	---------	----

### Cover; 1 m long

	transparent	885-566	1
--	-------------	---------	---

### Clip; secures cover against slipping

	gray	885-580	100 (25)
--	------	---------	----------

### Stud terminal block; 3 studs; M8

Color	Item No.	PU
○ gray	885-308	20

### Item-Specific Accessories

#### Separator plate; 2 mm thick; 110.3 mm wide

	gray	885-528	25
---	------	---------	----

#### Separator plate with jumper slot; 2 mm thick; 110.3 mm wide

	gray	885-548	25
---	------	---------	----

### Jumper; 2-way

	2-way	885-408	5
	3-way	885-428	5

### Step-down jumper; from M8 to M6

		885-448	5
---	--	---------	---

### Empty housing; 22.8 mm thick

	gray	885-508	20
---	------	---------	----

### Cover; 1 m long

	transparent	885-566	1
---	-------------	---------	---

### Clip; secures cover against slipping

	gray	885-580	100 (25)
---	------	---------	----------

### Stud terminal block; 3 studs; M10

Color	Item No.	PU
○ gray	885-310	10

### Item-Specific Accessories

#### Separator plate; 2 mm thick; 157 mm wide

	gray	885-530	25
---	------	---------	----

#### Separator plate with jumper slot; 2 mm thick; 157 mm wide

	gray	885-550	25
---	------	---------	----

### Jumper; 2-way

	2-way	885-410	5
	3-way	885-430	5

### Step-down jumper; from M10 to M6

		885-470	5
---	--	---------	---

### Empty housing; 33.8 mm thick

	gray	885-510	20
---	------	---------	----

### Cover; 1 m long

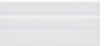
	transparent	885-570	1
---	-------------	---------	---

### Clip; secures cover against slipping

	gray	885-580	100 (25)
---	------	---------	----------

① Conductor cross-section  
DIN 46234: 1 cable lug per side: 2.5 ... 35 mm<sup>2</sup>  
DIN 46234: 2 cable lugs per side: 2.5 ... 35 mm<sup>2</sup>  
DIN 46235: 1 cable lug per side: 6 ... 25 mm<sup>2</sup>  
DIN 46235: 2 cable lugs per side: 6 ... 25 mm<sup>2</sup>

② Conductor cross-section  
DIN 46234: 1 cable lug per side: 2.5 ... 50 mm<sup>2</sup>  
DIN 46234: 2 cable lugs per side: 2.5 ... 50 mm<sup>2</sup>  
DIN 46235: 1 cable lug per side: 6 ... 35 mm<sup>2</sup>  
DIN 46235: 2 cable lugs per side: 6 ... 35 mm<sup>2</sup>

③ Conductor cross-section  
DIN 46234: 1 cable lug per side: 6 ... 120 mm<sup>2</sup>  
DIN 46234: 2 cable lugs per side: 6 ... 120 mm<sup>2</sup>  
DIN 46235: 1 cable lug per side: 10 ... 95 mm<sup>2</sup>  
DIN 46235: 2 cable lugs per side: 10 ... 95 mm<sup>2</sup>

④ 1000 V = rated voltage  
8 kV = rated impulse voltage  
3 = pollution degree

Please observe the application notes of the cable lug manufacturers regarding the strip length and the appropriate conductor cross sections.

Approvals and corresponding ratings,  
visit [www.wago.com](http://www.wago.com)

## Marking System

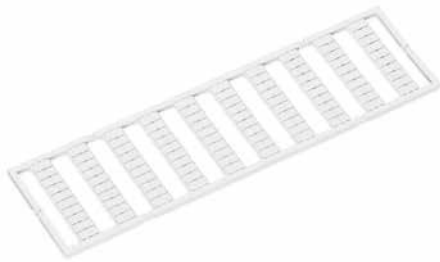

WMB marker card; plain; 10 strips with 10 markers/card			
Color	5 mm Item No.	5 ... 5.2 mm Item No.	PU
○ white	793-501	793-5501	5
● yellow	793-501/000-002	793-5501/000-002	5
● red	793-501/000-005	793-5501/000-005	5
● blue	793-501/000-006	793-5501/000-006	5
○ gray	793-501/000-007	793-5501/000-007	5
● orange	793-501/000-012	793-5501/000-012	5
● light green	793-501/000-017	793-5501/000-017	5
● green	793-501/000-023	793-5501/000-023	5
● violet	793-501/000-024	793-5501/000-024	5



WMB Inline; plain; 1,500 WMB markers (5 mm)/reel; stretchable 5 ... 5.2 mm		
Color	5 ... 5.2 mm Item No.	PU
○ white	2009-115	1

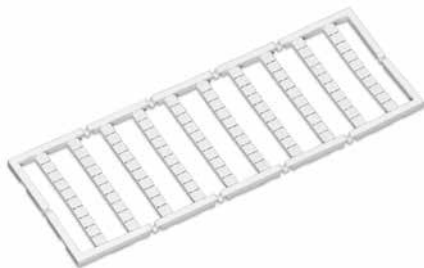

Mini-WSB marker card; plain; 10 strips with 10 markers/card		
Color	Item No.	PU
○ white	248-501	5
● yellow	248-501/000-002	5
● red	248-501/000-005	5
● blue	248-501/000-006	5
○ gray	248-501/000-007	5
● orange	248-501/000-012	5
● light green	248-501/000-017	5
● green	248-501/000-023	5
● violet	248-501/000-024	5



Mini-WSB Inline; plain; 1,700 markers (5 mm)/reel; stretchable 5 ... 5.2 mm		
Color	Item No.	PU
○ white	2009-145	1

## Marking System



Marker carrier; for lateral marker slots; 5 mm wide		
Color	Item No.	PU
<input type="radio"/> gray	2009-198	200 (25)



Marking strip; plain; 11 mm wide; 50 m reel		
Color	Item No.	PU
<input type="radio"/> white	2009-110	1

## Terminating Aluminum Conductors to Screw and Stud Terminal Blocks

### Terminating Aluminum Conductors to Screw Terminal Blocks

Screw-clamp terminal blocks directly connect round solid (RS) or sector-shaped solid (SS) aluminum conductors on one or both sides in compliance with the restrictions and processing instructions given in this description.

Item number	Approved combinations of screw terminal blocks with aluminum conductors													
	2.5 mm <sup>2</sup>	4 mm <sup>2</sup>	6 mm <sup>2</sup>	10 mm <sup>2</sup>	16 mm <sup>2</sup>	25 mm <sup>2</sup>	35 mm <sup>2</sup>	50 mm <sup>2</sup>	70 mm <sup>2</sup>	95 mm <sup>2</sup>	120 mm <sup>2</sup>	150 mm <sup>2</sup>	185 mm <sup>2</sup>	240 mm <sup>2</sup>
883-350x	RS	RS	RS	RS	RS	RS	RS							
883-700x					RS	RS	RS	SS	SS					
883-120x							RS	SS	SS	SS	SS			
883-240x												SS	SS	SS

The following restrictions apply to the direct connection of conductors in standard environments:

- The conductor/terminal block combination used must correspond to a combination of the above table "Approved combinations of screw terminal blocks with aluminum conductors."
- The aluminum conductors used must be round solid conductors (RS) or sector-shaped solid conductors (SS).
- For all other types of stranded aluminum conductors, appropriate aluminum/copper compression connectors must be used to connect the conductor to a terminal block.
- Sector-shaped solid conductors (SS) must comply with conductor class 1, sector-shaped, solid,  $\alpha=90^\circ$ .
- Contact must always be made between the large radius and the current bar to achieve the maximum contact surface.



Sector-shaped solid conductor (SS) of conductor class 1 ( $\alpha = 90^\circ$ )



Connecting a sector-shaped conductor to a 120 mm<sup>2</sup> screw through terminal block

### Note:

Connection in humid environments or corrosive atmospheres is generally problematic, because this can easily lead to an excessive aluminum oxidation. In this case, the use of suitable aluminum/copper press connectors with copper connection studs (even when using solid aluminum conductors) is absolutely necessary to ensure a reliable connection over extended periods of time.

### Example:

Rail-mount terminal blocks are installed in the outdoor cabinets of solar or wind power plants, which are subject to large temperature fluctuations throughout the year due to their installation site and environment. Therefore, in some circumstances, condensation water can form in the control cabinet or in the housing.

### Terminating Aluminum Conductors to Stud Terminal Blocks

For connecting aluminum conductors to 884 and 885 Series Stud Terminal Blocks, appropriate ring-shaped aluminum/copper compression cable lugs must be crimped to the conductor ends.

## Processing Information for Terminating Aluminum Conductors



Syringe; contains 20 ml "Alu-Plus" Contact Paste

Item No.	PU
249-130	20 (5)

### For terminating aluminum conductors, the following additional instructions for conductor preparation apply:

A thin, electrically non-conductive oxide layer forms on the surface of aluminum conductors during stripping. This layer must be removed to create a conductive and gas-tight connection.

The following measures must therefore be taken to ensure a reliable contact:

- The installation and operating location must be kept free of moisture or corrosive atmosphere.
- The strip length specified in the technical data of the terminal blocks must be observed.
- The conductor end must be freed of its oxide layer with a clean scraper and immediately dipped into acid- and alkali-free (neutral) petroleum jelly (Alu-Plus Contact Paste, 249-130) and connected directly to the rail-mount terminal block.
- The screw within the clamp body must be tightened to the maximum permissible torque specification of the respective terminal block.
- After a few days, the connection must be tightened again.
- Repeat these measures whenever you connect a new cable or reconnect a previously used cable.

# DIN-Rail and End Stop

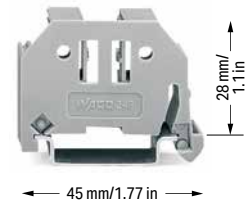

Dimensions in mm

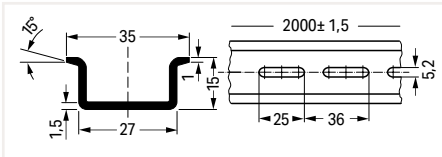

Steel DIN-rail; I<sub>N</sub> 125 A (based on 1 m length); 35 x 15 mm; 1.5 mm thick; 2 m long; similar to EN 60715

	Item No.	PU
unslotted	210-114	10(1)
slotted	210-197	10(1)

Hole width: 25 mm; Hole spacing: 36 mm

slotted	210-112	10(1)
---------	---------	-------

Hole width: 18 mm; Hole spacing: 25 mm

slotted	210-115	1
---------	---------	---

Dimensions in mm

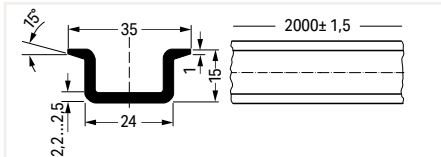

Steel DIN-rail; I<sub>N</sub> 125 A (based on 1 m length); 35 x 15 mm; 2.3 mm thick; 2 m long; per EN 60715

	Item No.	PU
unslotted	210-118	10(1)

Screwless end stop; for DIN-35 rail; 10 mm wide

Color	Item No.	PU
○ gray	249-117	100(25)



Dimensions in mm

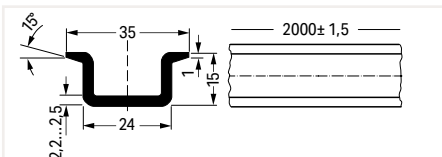

Copper DIN-rail; I<sub>N</sub> 309 A (based on 1 m length); 35 x 15 mm; 2.3 mm thick; 2 m long; per EN 60715

	Item No.	PU
unslotted	210-198	10(1)

Dimensions in mm

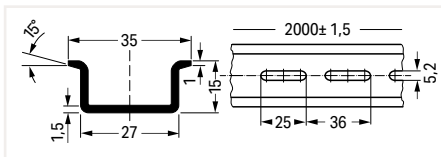

Steel DIN-rail; I<sub>N</sub> 125 A (based on 1 m length); 35 x 15 mm; 1.5 mm thick; 2 m long; per EN 60715

	Item No.	PU
unslotted	210-506	1
slotted	210-508	1

Screwless end stop; for DIN-35 rail; 14 mm wide

Color	Item No.	PU
○ gray	249-197	10

## Item Number Index

Item No.	Page	Item No.	Page	Item No.	Page	Item No.	Page
<b>210 Series</b>		<b>883 Series</b>					
210-112	26	883-7042	6				
210-114	26	883-7043	6				
210-115	26	883-7044	6				
210-118	26	883-7086	6				
210-197	26	883-7088	6				
210-198	26	883-7099	6				
		<b>884 Series</b>					
210-506	26	884-1200	14				
210-508	26	884-1242	14				
		884-1243	14				
<b>248 Series</b>		884-1280	14				
248-501	22	884-1284	14				
248-501/000-002	22	884-1286	14				
248-501/000-005	22						
248-501/000-006	22	884-1800	15				
248-501/000-007	22	884-1842	15				
248-501/000-012	22	884-1843	15				
248-501/000-017	22						
248-501/000-023	22	884-3000	15				
248-501/000-024	22	884-3042	15				
		884-3043	15				
<b>249 Series</b>		884-3080	15				
249-117	26	884-3084	15				
249-130	25	884-3086	15				
249-197	26						
		884-3500	14				
<b>793 Series</b>		884-3542	14				
793-501	22	884-3543	14				
793-501/000-002	22	884-3580	14				
793-501/000-005	22	884-3584	14				
793-501/000-006	22	884-3586	14				
793-501/000-007	22						
793-501/000-012	22	884-7000	14				
793-501/000-017	22	884-7042	14				
793-501/000-023	22	884-7043	14				
793-501/000-024	22	884-7080	14				
		884-7084	14				
		884-7086	14				
793-5501	22						
793-5501/000-002	22	<b>885 Series</b>					
793-5501/000-005	22	885-106	18				
793-5501/000-006	22	885-108	18				
793-5501/000-007	22	885-110	18				
793-5501/000-012	22	885-112	19				
793-5501/000-017	22						
793-5501/000-023	22	885-306	20				
793-5501/000-024	22	885-308	20				
		885-310	20				
<b>883 Series</b>		885-406	18				
883-1201	8	885-408	18				
883-1204	8	885-410	18				
883-1230	8	885-412	19				
883-1242	8	885-426	18				
883-1243	8	885-428	18				
883-1244	8	885-430	18				
883-1286	8	885-432	19				
883-1288	8	885-448	18				
883-1299	8	885-470	18				
883-2401	10	885-506	18				
883-2404	10	885-508	18				
883-2442	10	885-510	18				
883-2443	10	885-526	18				
883-2486	10	885-528	18				
883-2499	10	885-530	18				
		885-546	18				
883-3501	4	885-548	18				
883-3504	4	885-550	18				
883-3507	4	885-566	18				
883-3530	4	885-570	18				
883-3542	4	885-580	18				
883-3586	4						
883-3588	4	<b>2009 Series</b>					
		2009-110	23				
883-7001	6	2009-115	22				
883-7004	6	2009-145	22				
883-7007	6	2009-198	23				
883-7030	6						

## WAGO Worldwide Companies and Representatives

- Algeria**  
Please contact WAGO France
- Argentina**  
Bruno Schillig S.A.  
Arenales 4030, B1604CFD  
Florida, PBA  
Phone +54 11 4730 1100  
Fax +54 11 4761 7244  
wago@schillig.com.ar
- Armenia**  
ROOT ITSP LLC  
33 Halabyan str.  
0038, Yerevan  
info@root.am
- Australia**  
WAGO Pty. Ltd.  
2-4 Overseas Drive  
Noble Park Victoria 3174  
Phone +61 03 8791 6300  
Fax +61 03 9701 0177  
sales.anz@wago.com
- Austria**  
WAGO Kontakttechnik Ges.m.b.H.  
Europaring F15 602  
Campus 21  
2345 Brunn am Gebirge  
Phone +43 1 6150780  
Fax +43 1 6150775  
wago-at@wago.com
- Azerbaijan**  
AZ Technics LTD  
Zulfi V. Alizade  
Y.Safarov str.33, AZ1025,  
Baku  
Phone +994 50 210 24 49  
Fax +994 12 496 83 34  
info@AZtechnics.az
- Bangladesh**  
Please contact WAGO India
- Belarus**  
DemsEnergO LLC  
Vostochnaya Str. 39, Office 1N.  
220040 Minsk  
Phone +375 17 2102189  
Fax +375 17 2102189  
dems@dems.by
- ATAVA Techno Ltd.  
Ul. Denisovskaya 47, office 1  
220006 Minsk  
Phone +375173881018  
atava@atava.by
- Belgium**  
WAGO BeLux nv  
Excelsiorlaan 11  
1930 Zaventem  
Phone +32 2 717 9090  
Fax +32 2 717 9099  
info-be@wago.com
- Bolivia**  
ISOTEK S.R.L.  
Zona Casco Viejo  
Calle Isso #578, B/San Roque  
Santa Cruz  
Phone +591 721 000 27  
info@isotek.bo
- Bosnia & Herzegovina**  
Please contact WAGO Bulgaria
- Brazil**  
WAGO Eletroeletrônicos Ltda  
Rua Tripoli, 640, Loteamento Multivias II  
Jardim Ermida I  
Jundiaí - SP  
CEP 13212-217  
Phone +55 (11) 2923 7200  
info.br@wago.com
- Bulgaria**  
WAGO Kontakttechnik GmbH & Co. KG  
Representative Office Sofia  
Business Center Serdiika  
2E Akad. Ivan Geshov Blvd.  
Building 1, Floor 4, Office 417  
1330 Sofia  
Phone +359 2 489 46 09/10  
Fax +359 2 928 28 50  
info-BG@wago.com
- Canada**  
WAGO Canada, Inc.  
1550 Yorkton Court - Unit 1  
Burlington, ON L7P 5B7  
Phone +1-888-9246-221  
info.ca@wago.com
- Chile**  
Desimat Chile  
Av Puerto Vespuccio 9670  
Pudahuel Santiago  
Phone +56 2 747 0152  
Fax +56 2 747 0153  
ventaschile@desimat.cl
- China**  
WAGO Electronic (Tianjin) Co., Ltd.  
No.5, Quan Hui Road  
Wuqing Development Area  
Tianjin 301700  
Phone +86 22 5967 7688  
Fax +86 22 5961 7668  
info-cn@wago.com
- Colombia**  
T.H.L. Ltda.  
Cra. 49 B #91-33  
Bogotá  
Phone +57 1 621 85 50  
Fax +57 1 621 60 28  
ventas-thl2@thl.com.co
- Croatia**  
M.B.A. d.o.o.  
Frana Supila 5  
51211 Matulji  
Phone +385 51 275-736  
Fax +385 51 275-066  
mba@ri.htnet.hr
- MICROSTAR d.o.o.  
Siget 18 b  
10020 Zagreb  
Phone +385 1 3647 849  
Fax +385 1 3636 662  
wago@microstar.hr
- Czech Republic**  
WAGO Elektro spol. sr. o.  
Rozvodova 1116/36  
143 00 Praha 12 - Modřany  
Phone +420 261 090 143  
info.cz@wago.com  
wago-cz@wago.com
- Denmark**  
WAGO Denmark A/S  
Lejrvej 17  
3500 Værløse  
Phone +45 44 357 777  
info.dk@wago.com
- Ecuador**  
ECUAINSETEC CIA LTDA  
Yugoslavia N34-110 y Azuay  
Quito  
Phone +593 2 24 50 475  
Fax +593 2 22 51 242  
g.castro@ecuainsetec.com.ec
- Egypt**  
IBN Engineering / Distributor (Automation  
Products)  
Phone +2 02 3 721 43 50  
Fax +2 02 3 722 17 09  
nasrelwy@ibnengineering.com
- Estonia**  
Eltarko OÜ  
Treiali tee 2 door 6  
Peetri küla  
Rae vald  
75312 Harjumaa  
Phone +372 651 7731/32  
Fax +372 651 7786  
andres@eltarko.ee
- Finland**  
WAGO Finland Oy  
Äyritie 12 B  
01510 Vantaa  
Phone +358 9 7744 060  
Fax +358 9 7744 0660  
info.fi@wago.com
- France**  
WAGO Contact SAS  
Paris Nord 2  
83 Rue des Chardonnerets  
93290 - Tremblay en France  
B.P. 95947 - ROISSY CDG CEDEX  
Phone +33 1 4817 2590  
Fax +33 1 4863 2520  
info-fr@wago.com
- Germany**  
WAGO Kontakttechnik GmbH & Co. KG  
Hansastraße 27  
32423 Minden  
Phone +49 571 887-0  
Fax +49 571 887-169  
info@wago.com
- WAGO Kontakttechnik GmbH & Co. KG  
Waldstraße 1  
99706 Sondershausen  
Phone +49 3632 659-0  
Fax +49 3632 659-100  
info@wago.com
- Great Britain**  
WAGO Limited  
Triton Park, Swift Valley Industrial Estate  
RUGBY  
Warwickshire, CV21 1SG  
Phone +44 1788 568 008  
Fax +44 1788 568 050  
uksales@wago.com
- Greece**  
PANAGIOTIS SP. DIMOULAS  
DIMOULAS AUTOMATIONS  
Kritis Str. 26  
10439 Athens  
Phone +30 210 883 3337  
Fax +30 210 883 4436  
wago.info@dimoulas.com.gr
- Honduras**  
CILASAS S.A. de C.V.  
Barrio Los Andes  
7 Calle entre 14 y 15 Ave. N.O.  
P.O. Box. 1061  
San Pedro Sula  
Phone +504 2557 1146/7  
Fax +504 2557 1149  
ventas@iecilasa.com
- Hong Kong**  
National Concord Eng., Ltd.  
Unit A-B, 5/F.  
Southeast Industrial Building  
611-619 Castle Peak Road  
Tsuen Wan, N.T.  
Phone +852 2429 2611  
Fax +852 2429 2164  
sales@nce.com.hk
- Hungary**  
WAGO Hungária KFT  
Ipari Park, Gyár u. 2  
2040 Budapest  
Phone +36 23 502-170  
Fax +36 23 502-1  
info.hu@wago.com
- Iceland**  
Johan Rönning ehf / S.Gudjonsson  
Smidjuvegur 3  
200 Kopavogur  
Phone +354 520-4500  
Fax +354 520-4501  
export@wago.com
- India**  
WAGO Private Limited  
C-27, Sector-58, Phase-III  
Noida-201 301  
Uttar Pradesh-201301  
Phone +91 120 438 8700  
Fax +91 120 438 8799  
info.india@wago.com
- Indonesia**  
Please contact WAGO Singapore
- Iraq**  
Please contact WAGO Middle East
- Ireland**  
Drives & Controls  
Unit F4, Riverview Business Park  
Nangor Road  
Dublin 12  
Phone +353 1 4604474  
Fax +353 1 4604507  
info@drivesandcontrols.ie
- Israel**  
Comtel Israel Electronic Solutions Ltd.  
Bet Hapaamon  
20 Hataas Street  
P.O. Box 66  
44425 Kefar-Saba  
Phone +972 9 76 77 240  
Fax +972 9 76 77 243  
sales@comtel.co.il
- Italy**  
WAGO Elettronica SRL a Socio Unico  
Via Parini 1  
40033 Casalecchio di Reno (BO)  
Phone +39 051 6132112  
Fax +39 051 6132888  
info-ita@wago.com
- Japan**  
WAGO Co. of JAPAN Ltd.  
Kinshicho Prime Tower  
1-5-7, Kameido, Koto-ku  
Tokyo 136-0071  
Phone +81 3 5627 2050  
Fax +81 3 5627 2055  
info-jp@wago.com
- Jordan**  
Oxgen for Engineering Systems Co. L.L.C  
PO Box: 2154 Amman  
11953 Jordan  
Phone +962 79 9 860 869  
Fax. +962 655 211 89  
info@oxgn-grp.com
- Kazakhstan**  
Axima LLP  
232/2, Ryskulov avenue  
050061 Almaty  
Phone +7 727 356 52 91/92/93  
Fax +7 727 327 14 92/93  
trade1@axima.kz  
or@axima.kz
- Technik-Tade LLC  
Kabanbay Batyra Str. 11  
office 305  
070004 Ust-Kamenogorsk  
Phone +7 7232 254064  
Fax +7 7232 253251  
info@technik.kz
- Korea**  
WAGO Korea Co., Ltd.  
Room A413~A416, A dong,  
Indukwon IT Valley Building, Imiro 40,  
Poil-dong,Uiwang-Si, Gyeonggi-do,  
16006, South Korea  
Phone +82 31 421 9500  
Fax +82 31 360 2476  
info.korea@wago.com
- Kosovo**  
Please contact WAGO Bulgaria
- Latvia**  
INSTABALT LATVIA SIA  
Vestienas iela 6  
Riga, LV-1035  
Phone +371 6790 1188  
Fax +371 6790 1180  
info@instabalt.lv
- Lebanon**  
Gemayel Trading & Contracting  
Rue 55, Antonins Project-Bloc L  
P.O. BOX 70-1096  
Antelias, Lebanon  
Phone +961 3 22 30 29  
Fax +961 4 52 10 29  
info@gtclb.com
- Lithuania**  
INSTABALT LIT UAB  
Savanorių 187  
Vilnius, 2053  
Phone +370 52 322 295  
Fax +370 52 322 247  
info@instabalt.lt
- Luxembourg**  
Please contact WAGO Belgium
- Malaysia**  
WAGO Automation Sdn. Bhd.  
No 806, Block A4, Leisure Commerce  
Square,  
No 9, Jalan PJS 8/9, 46150 Petaling Jaya,  
Selangor Darul Ehsan, Malaysia  
Phone +60 3 7877 1776  
Fax +60 3 7877 2776  
info-my@wago.com

**Maledivea**

Please contact WAGO India

**Mexico**

WAGO S.A. de C.V.  
Carretera estatal 431 Km. 2+200  
Lote 99 Módulo 6  
Parque Industrial Tecnológico Innovación  
Querétaro  
El Marqués, Qro. 76246  
Phone +52 442 221 5946  
Fax +52 442 221 5063  
info.mx@wago.com

**Morocco**

Automatisme & Connection Maroc  
23, Rue Boured  
2ème étage, appt4  
Roche Noire  
20300 Casablanca  
Phone +212 522 24 21 72/73  
Fax +212 522 24 21 75  
info-fr@wago.com

**Nepal**

Please contact WAGO India

**Netherlands**

WAGO Nederland B.V.  
Laan van de Ram 19  
7234 BW APELDOORN  
Phone +31 55 36 83 500  
Fax +31 55 36 83 599  
info-nl@wago.com

**New Zealand**

Please contact WAGO Australia

Engineering Computer Services Ltd  
7-19 Ruffell Rd  
Hamilton, 3200  
New Zealand  
Phone +64 (0) 7 849 2211  
Fax +64 (0) 7 849 2220  
sales@ecsnz.com

**Nigeria**

GIL Automations Ltd.  
Daily Times Complex  
2 Lateef Jakande Rd., Agidingbi  
100271 Ikeja, Lagos State  
Phone +234 17132672335  
sales@gilautomation.com

**Norway**

WAGO Norge AS  
Jerikoveien 20  
1067 Oslo  
Phone +47 22 30 94 50  
Fax +47 22 30 94 51  
info.no@wago.com

**Oman**

Please contact WAGO Middle East

**Pakistan**

FuziLogix Automation & Control  
Suit No. 14, 5th Floor, Shan Arcade  
New Garden Town, Lahore  
Phone +92 42 594 1503 - 4  
Fax +92 42 585 1431  
info@fuzilogix.com

**S.A. Hamid & Co.**

7 Brandreth Road  
Lahore, 54000  
Phone +92 42 376 500 99  
Fax +92 42 376 513 91  
sales@sahamid.com

**Paraguay**

AESA  
Av. Madame Lynch  
c/Antolin Irala  
2309 Asunción  
Phone +59 521674524  
info@aesa.com.py

**Philippines**

Please contact WAGO Singapore

**Poland**

WAGO ELWAG sp. z o. o.  
ul. Piękna 58 a  
50-506 Wrocław  
Phone +48 71 3602970  
Fax +48 71 3602999  
wago.elwag@wago.com

**Portugal**

MORGADO & CA. LDA - SEDE  
Estrada Exterior da  
Circunvalação 3558/3560  
Apartado 1057  
4435 Rio Tinto  
Phone +351 22 9770600  
Fax +351 22 9770699  
geral@morgadocl.pt

**Quatar**

GEBD - Gulf European Business  
Development - Company W.L.L.)  
PO Box: 20 000  
Doha, Quatar  
Phone +974 5591 5682  
info@gebdc.com

**Republic of Moldova**

Smart Delight SRL  
Bulgara Str. 9/6  
2001 Chisinau  
Phone +373 (373) 69 10 22 01  
alexandres@starnet.md

**Republic of North Macedonia**

Please contact WAGO Bulgaria

Kompjunet Inzenering  
Vladimir Komarov 1A-3/9  
1000 Skopje  
Phone +389 2 521 12 00

**Romania**

WAGO Kontakttechnik GmbH & Co. KG  
Representative Office Romania  
Sos. Pipera-Tunari nr. 1/1  
building 1, 2nd floor  
077190 Voluntari, Ilfov  
Phone +40-(0)31 421 85 68  
info-RO@wago.com

**Russia**

OOO WAGO Contact Rus  
Ilinskaya strret 5, bldg. 2  
127576 Moscow  
Phone +7 495 223-4747  
info.ru@wago.com  
www.wago.ru

**Saudi Arabia**

Saudi Electronic Trading  
P.O. Box 60712  
Riyadh 11555  
Phone +966 11 2063 377  
Fax +966 11 4633 297  
info@setra.com.sa

**Serbia**

Please contact WAGO Bulgaria

Mehatronik Sistem d.o.o.  
Bul. Oslobodjenja 30  
32000 Cacak  
Phone +381 (0)32 310 088  
Fax. +381 (0)32 371 571  
Mobil +381 (0)64 877 22 02  
office@mehatronik.com

**Sigma Controls Engineering d.o.o.**

Jovana Skerlica 22  
18000 Nis  
Mobil +381 (0)63 403 104  
zeljko.savic@sce.rs

**Singapore**

WAGO Electronic Pte Ltd  
138 Joo Seng Road #06-01  
Singapore 368361  
Phone +65 62866776  
Fax +65 62842425  
info-sing@wago.com

**Slovakia**

Proelektro spol. s r.o.  
Na barine 22  
841 03 Bratislava - Lamač  
Phone +421 2 4569 2503  
info@wago.sk

**Slovenia**

IC elektronika d.o.o.  
Vodovodna cesta 100  
1000 Ljubljana  
Phone +386 1568 01 26  
Fax +386 1568 91 07  
info@ic-elect.si

**Slovenia**

Elektronabava d.o.o.  
Cesta 24 junija 3  
1231 Ljubljana  
Phone +386 1 58 99 300  
Fax +386 1 58 99 409  
info@elektronabava.si

**South Africa**

Shorrock Automation CC  
Nelmapius drive  
5 Regency Drive, Route 21 Corp. Park  
0051 Centurion  
Phone +27 12 4500300  
Fax +27 12 4500322  
sales@shorrock.co.za

**Spain**

DICOMAT S.L.  
Avda. de la Industria, 36  
Apartado Correos, 1.178  
28108-Alcobendas (Madrid)  
Phone +34 91 662 1362  
Fax +34 91 661 0089  
info@dicomat-asetyc.com

**Sri Lanka**

Please contact WAGO India

**Sweden**

WAGO Sverige AB  
Box 11127, 161 11 BROMMA  
Besöksadress: Adolfsbergsv. 31  
Phone +46 858410680  
info.se@wago.com

**Switzerland**

WAGO CONTACT SA  
Rte. de l'Industrie 19  
Case Postale 168  
1564 Domdidier  
Phone +41/26 676 75 00  
Fax +41/26 676 75 01  
info.switzerland@wago.com

**Syria**

Please contact WAGO Middle East

**Taiwan R.O.C.**

WAGO Contact, Ltd.  
5F, No.168, Jiankang Rd  
Zhonghe City  
Taipei County 23585, Taiwan  
Phone +886 2 2225 0123  
Fax +886 2 2225 1511  
info.taiwan@wago.com

**Thailand**

WAGO Contact Ltd.  
4th Floor, KS Building  
213/6-8 Rachada-Phisek Road  
Dingdaeng Bangkok 10400  
Phone +66 2 6935611  
Fax +66 2 6935612  
info-th@wago.com

**Tunisia**

Please contact WAGO France

**Turkey**

WAGO Elektronik Sanayi ve Ticaret Ltd. Şti.  
Yukarı Dudullu Mahallesi Bayraktar Bulvarı  
Cad. Hattat Sok. No. 10  
34775 Ümraniye - İstanbul  
Phone +90 216 472 1133  
Fax +90 216 472 9910  
info.tr@wago.com

**Ukraine**

LLC RPE „Logicon“  
Predslavinskaya street, 37, office 303  
03150 Kiev  
Phone +380 44 5228019  
Fax +380 44 2611803  
info@logicon.ua

**Micropribor Ltd.**

4, Krzhizhanovsky Str.  
03142 Kiev  
Phone +380 44 392 93 86  
Fax +380 44 392 93 87  
sales@micropribor.kiev.ua

**United Arab Emirates (UAE)**

WAGO Middle East (FZC)  
SAIF Zone, Q4-282  
P.O. Box 120665  
Sharjah, UAE  
Phone +971 6 5579920  
Fax +971 6 5579921  
info.uae@wago.com

**Uruguay**

Fivisa Electricidad  
Avda. Uruguay 1274  
11100 Montevideo  
Phone +59 829 020 808  
Fax +59 829 021 230  
info@fivisa.com.uy

**USA**

WAGO CORPORATION  
N120 W19129 Freistadt Road  
Germantown, WI 53022  
Phone +1 262 255 6222  
Fax +1 262 255 3232  
Toll-Free: 1-800 DIN Rail (346-7245)  
info.us@wago.com

**Venezuela**

PETROBORNAS, C.A.  
C.C. PLAZA AEROPUERTO - PISO 1 - LO-  
CAL P1-B-03  
(8015) UNARE - PUERTO ORDAZ -  
ESTADO BOLÍVAR  
REPÚBLICA BOLIVARIANA DE  
VENEZUELA  
Phone +58 286 951 3382  
Fax +58 286 951 3382  
info@petrobornas.com

**Vietnam**

Please contact WAGO Germany (Minden)

Version: 10/2020

Current addresses at www.wago.com









**WAGO Kontakttechnik GmbH & Co. KG**

Postfach 2880 · 32385 Minden  
Hansastraße 27 · 32423 Minden  
[info@wago.com](mailto:info@wago.com)  
[www.wago.com](http://www.wago.com)

Headquarters	+49 (0)571/ 887 - 0
Sales	+49 (0)571/ 887 - 44222
Orders	+49 (0)571/ 887 - 44333
Fax:	+49 (0)571/ 887 - 844169

WAGO is a registered trademark of WAGO Verwaltungsgesellschaft mbH.

“Copyright – WAGO Kontakttechnik GmbH & Co. KG – All rights reserved. The content and structure of the WAGO websites, catalogs, videos and other WAGO media are subject to copyright. Distribution or modification of the contents of these pages and videos is prohibited. Furthermore, the content may neither be copied nor made available to third parties for commercial purposes. Also subject to copyright are the images and videos that were made available to WAGO Kontakttechnik GmbH & Co. KG by third parties.”